

**Economical inverter with simple operation**

# NE-S1 Series



# What's "NES"?

New Inverter  
Small, Simple

**N** Next & New  
NEXT generation inverter opens the door to NEW market segments

**E** Ecological & Economical  
ECOLOGICAL - saves energy  
ECONOMICAL - simple to install and easy to use

## Space Saving

### ● Among the smallest form-factors in their category:

- 43% smaller than equivalent X200 (0.2 kW)
- Side-by-side installation to save panel space

### ● FFM: The top cover for NE-S1 series.

Optional top cover NES1-FFM-M (Afterward FFM) for exclusive use to improve usability of the inverter. Applicable model: NES1-015~022SB/LB, 007~040HB

### Effect to reduce installation space

Generally, in the inverter installation, so as not to disturb the ventilation, space of the top and bottom of inverter requires more than 10cm. By attaching FFM, ventilation is exhausted to the front. Therefore, the space of the top and bottom of inverter may be reduced to 2cm, saving panel space and cost to the overall installation.

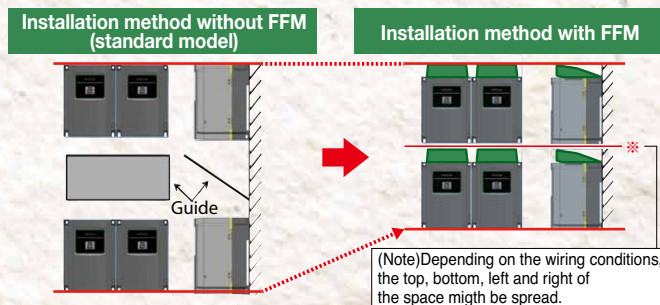

No space between



\* Side-by-side installation: derating for carrier frequency and output current required

### Effect to improve derating properties

Derating properties are improved by attaching FFM at the NES1-015SB, NES1-022SB and NES1-040HB.

Derating of carrier frequency and current at ambient temperature 50°C is not required for some models. Please refer "Derating Curves" page for more detail.

### Effect to improve Capacitor life

By attaching FFM to applicable model, the expected life of the aluminum electrolytic capacitors is approximately doubled, adding longevity to the inverter.



### Reduce invasion of dust into product

Since upper aperture of NE-S1 series is blind structure, dust from the top is hard to invasion into the products directly.

Furthermore, by attaching FFM, falling dust intrusion is reduced significantly, further enhancing service life.

## 2 Simple Operation

Two types of operator is available.

- Run/Stop/Reset is integrated in one button for simple operation.
- Full-function field attachable operator available as an option. (refer to P.5 and P.15)

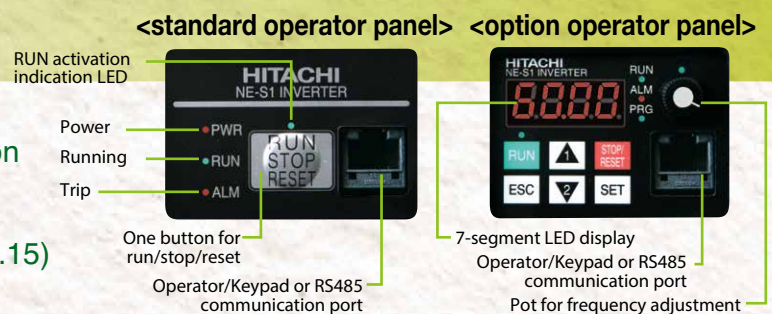

## 3 Global Standards

- Conformity to global standards  
Conforms to CE/UL/c-UL/c-Tick

- Compatible to both sink and source logic as standard  
(Configurable with a provided Jumper.)





# Developed by Hitachi and Economical

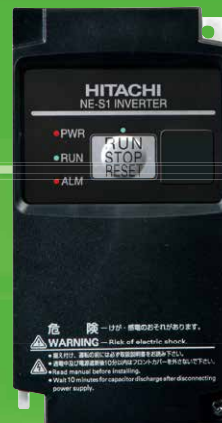

## S Small&Simple

SIMPLE functions in a SMALL package

## 4 For Network

- RS485 Modbus-RTU Communication port is standard

## 6 Inherent Functions to achieve energy savings

Automatic energy saving function is implemented to minimize energy consumption.

- **Arithmetic and Delay Functions**  
Arithmetic operation and delay functions simplify external circuit.
- **Keypad / Terminal Switching**  
Source of frequency and run commands can be selected via intelligent terminal.
- **2nd Motor Function**  
Settings for 1st and 2nd motor can be selected via intelligent input.
- **Three-wire Operation Function**  
Momentary contact for RUN and STOP can be utilized.
- **Analog Input Disconnection Detect Function**  
Upon the loss of analog signal, a preconfigured signal can be activated.  
\*Parameter change and setting by keypad etc.

## Model Configuration

Applicable motor kW(HP)	0.2(1/4)	0.4(1/2)	0.75(1)	1.5(2)	2.2(3)	4.0(5)
Three Phase 200V LB	●	●	●	●	●	
Single Phase 200V SB	●	●	●	●	●	
Three Phase 400V HB		●	●	●	●	●

## Model Name Indication

### NES1-002 S B E

Series Name	E : European version B : Without keypad Power Source
Applicable Motor Capacity	S : 1-phase 200V class L : 3-phase 200V class H : 3-phase 400V class
002: 0.2kW(1/4HP) -040: 4.0kW(3HP)	

## 5 Optional Customization

Customization for specific applications is available.  
(contact Hitachi)

## 7 Application

Optimal performance for energy saving applications such as fans and pumps



- Fan and air conditioners**
- air conditioning systems
  - fans and blowers
  - clean rooms



- Pumps**
- water and wastewater pump systems
  - tank-less water supply and drainage systems



- Food Processing Machines**
- slicers •mixers
  - confectionery machines
  - Fruit Sorters

## CONTENTS

Features	1-2
Standard Specifications	3
Dimensions	4
Operation and Programming	5
Operation / Terminal Functions	6
Function List	7-10
Protective Functions	11
Connecting Diagram	12-13
Wiring and Accessories	14-15
Torque characteristics/Derating Curves	16
For Correct Operation	17-18

ISO 14001 JQA-EM6974		Hitachi variable frequency drives (inverters) in this brochure are produced at the factory registered under the ISO 14001 standard for environmental management system and the ISO 9001 standard for inverter quality management system.
ISO 9001 JQA-1153		

# Standard Specifications

## ● 1-/3-phase 200V class

Model NES1-		002SB(E)	004SB(E)	007SB(E)	015SB(E)	022SB(E)	
Output Ratings	Applicable motor size, 4-pole kW(HP) *1	0.2(1/4)	0.4(1/2)	0.75(1)	1.5(2)	2.2(3)	
	Rated capacity	200V	0.4	0.9	1.3	3.4	
		240V	0.5	1.0	1.6	2.9	4.1
	Rated output current (A) *2		1.4	2.6	4.0	7.1	10.0
	Overload capacity(output current)		150% for 60 sec.				
Rated output voltage (V)		3-phase (3-wire) 200 to 240V (corresponding to input voltage)					
Input Rating	Rated input voltage (V)	SB: 1-phase 200 to 240V+10%, -15%, 50/60Hz ±5% LB: 3-phase 200 to 240V+10%, -15%, 50/60Hz ±5%					
	Rated input current (A)	SB	3.1	5.8	9.0	16.0	22.5
		LB	1.8	3.4	5.0	9.3	13.0
Enclosure *4		IP20					
Cooling method		Self-cooling			Force ventilation		
Weight (kg)	SB	0.7	0.8	1.0	1.2	1.3	
	LB	0.7	0.8	0.9	1.2	1.3	

## ● 3-phase 400V class

Model NES1-		004HB(E)	007HB(E)	015HB(E)	022HB(E)	040HB(E)	
Output Ratings	Applicable motor size, 4-pole kW(HP) *1	0.4(1/2)	0.75(1)	1.5(2)	2.2(3)	4.0(5)	
	Rated capacity (kVA)	380V	0.9	1.6	2.6	3.6	6.0
		480V	1.2	2.0	3.4	4.5	7.6
	Rated output current (A) *2		1.5	2.5	4.1	5.5	9.2
	Overload capacity(output current)		150% for 60 sec.				
Rated output voltage (V)		3-phase (3-wire) 380 to 480V (corresponding to input voltage)					
Input Rating	Rated input voltage (V)	3-phase 380 to 480V +10%, -15%, 50/60Hz ±5%					
	Rated input current (A)	2	3.3	5.2	7	11.7	
Enclosure *4		IP20					
Cooling Method		Self-cooling			Force ventilation		
Weight (kg)		0.9		1.0	1.1	1.2	

## General Specifications

Item		General Specifications		
Control	Control method	Line-to-line sine wave pulse-width modulation (PWM) control		
	Output frequency range *5	0.01 to 400Hz		
	Frequency accuracy *6	Digital command :±0.01%, Analog command±0.4% (25±10°C)		
	Frequency setting resolution	Digital: 0.01Hz, Analog: (max frequency)/1000		
	Voltage/Frequency Characteristic	V/f control, V/f variable (constant torque, reduced torque)		
	Acceleration/deceleration time	0.00 to 3000 sec. (linear, sigmoid), two-stage accel./decel.		
	Starting torque *7	100%/6Hz		
	Carrier frequency range	2.0 to 15kHz		
Input terminal	Protective functions	Over-current, Over-voltage, Under-voltage, Overload, Overheat, Ground fault at power-on, Input over-voltage, External trip, Memory error, CPU error, USP error, Driver error, Output phase loss protection		
	Specification	10kohm input impedance, sink/source logic selectable		
Output signal	Intelligent output terminal	Specification	FW(Forward), RV(Reverse), CF1-CF3(Multispeed command), JG(Jogging), DB(External DC braking), SET(Second motor constants setting), 2CH(Second accel./decel.), FRS(Free-run stop), EXT(External trip), USP(Unattended start protection), SFT(Software lock), AT(Analog input selection), RS(Reset), STA(3-wire start), STP(3-wire stop), F/R(3-wire fwd./rev.), PID(PID On/Off), PIDC(PID reset), UP/DWN(Remote-controlled accel./decel.), UDC(Remote-controlled data clearing), OPE(Operator control), SF1-SF3(multispeed bit), OLR(overload restriction selection), LAC(LAD cancellation), ADD(ADD frequency enable), F-TM(force terminal mode), KHC(cumulative power clearance), AHD(analog command holding), HLD(retain output frequency), ROK(permission of run command), DISP (display limitation), NO(Not selected)	
		Function	27V DC 50mA max open collector output, 1 terminals 1c output relay (AL0, AL1, AL2 terminals) RUN(run signal), FA1(Frequency arrival type 1 - constant speed), FA2(Frequency arrival type 2 - over-frequency), OL(overload advance notice signal), OD(Output deviation for PID control), AL(alarm signal), DC(Wire brake detect on analog input), FBV(PID Second Stage Output), NDC(ModBus Network Detection Signal), LOG(Logic Output Function), ODC(analog voltage input disconnection), LOC(Low load), FA3(Set frequency reached), UV(Under voltage), RNT(Operation time over), ONT(Plug-in time over), THM(Thermal alarm signal), ZS(0 Hz detection signal), IRDY(Inverter ready), FWR(Forward rotation),RVR(Reverse rotation), MJA(Major failure)	
Operator	Monitor output terminal	Function	PWM output; Select analog output frequency monitor, analog output current monitor or digital output frequency monitor	
	Operation key	1 unified key for RUN/STOP/RESET ON : this key has function of "RUN"(regardless run command source setting (A002/A201).) OFF : this key has function of "STOP/RESET When optional operator is connected, operation from key is disabled.		
Operation	Status LED Interface		Control power supply LED (Red),LED during operation (yellow-green),Operation button operation LED (yellow-green),LED during tripping (Red), 4LED in total	
	Frequency setting	Operator keypad(Optional)	Up and Down keys / Value settings or analog setting via potentiometer on operator keypad	
		External signal *8	0 to 10 V DC or 4 to 20 mA	
	FW/RV Run	Serial port	RS485 interface (Modbus RTU)	
		Operator Keypad(Optional)	Run key / Stop key (change FW/RV by function command)	
External signal		FW Run/Stop (NO contact), RV set by terminal assignment (NC/NO), 3-wire input available		
Environment	Serial port		RS485 interface (Modbus RTU)	
	Operating temperature		-10 to 50°C(carrier derating required for ambient temperature higher than 40°C(022SB:temperature higher than 30°C)), no freezing When attach option FFM, in 015/022SB the derating becomes needless.	
	Storage temperature		-20 to 60°C	
	Humidity		20 to 90% RH	
Vibration		5.9mm/s <sup>2</sup> (0.6G) 10 to 55Hz		
Location		Altitude 1,000 m or less, indoors (no corrosive gasses or dust)		
Other functions		AVR (Automatic Voltage Regulation), V/f characteristic selection, accel./decel. curve selection, frequency upper/lower limit, 8 stage multispeed, PID control, frequency jump, external frequency input bias start/end, jogging, trip history etc.		
Options		Remote operator with copy function (WOP), Remote operator (OPE-SRmini, OPE-SR), Operator (NES1-OP), input/output reactors, DC reactors, radio noise filters, LCR filter, communication cables (ICS-1, 3)		

Note 1: The applicable motor refers to Hitachi standard 3-phase motor (4-pole). When using other motors, care must be taken to prevent the rated motor current (50/60 Hz) from exceeding the rated output current of the inverter.

Note 2: The output voltage decreases as the main supply voltage decreases (except when using the AVR function). In any case, the output voltage cannot exceed the input power supply voltage.

Note 3: The braking torque via capacitive feedback is the average deceleration torque at the shortest deceleration (stopping from 50/60 Hz as indicated). It is not continuous regenerative braking torque. The average decel torque varies with motor loss. This value decreases when operating beyond 50 Hz.

Note 4: The protection method conforms to JIS C 920(IEC60529).

Note 5: To operate the motor beyond 50/60 Hz, consult the motor manufacturer for the maximum allowable rotation speed.

Note 6: The output frequency may exceed the maximum frequency setting (A004 or A204) for automatic stabilization control.

Note 7: At the rated voltage when using a Hitachi standard 3-phase, 4pole motor.

Note 8: DC 4 to 20 mA input, need parameter setting by Keypad etc.

Analog input voltage or current can be switched by switch as individually and not use them in the same time.

# Dimensions

## NES1-002SB(E), 004SB(E), 002LB, 004LB, 007LB

[Unit: mm(inch)]  
Inches for reference only

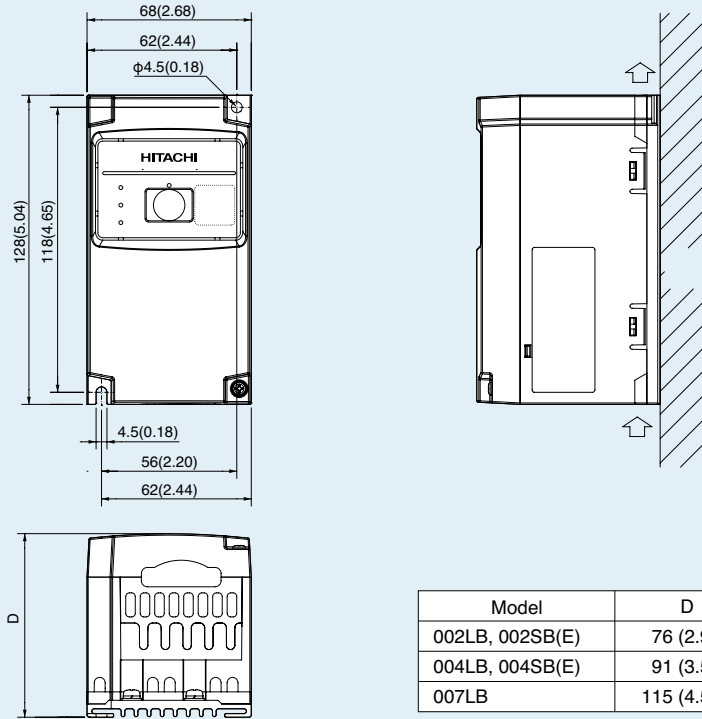

Model	D
002LB, 002SB(E)	76 (2.99)
004LB, 004SB(E)	91 (3.58)
007LB	115 (4.53)

\*002 to 007LB/002,004SB(E):without cooling fan.

## NES1-007SB(E), 015SB(E), 022SB(E), 015LB, 022LB, 004HB(E), 007HB(E), 015HB(E), 022HB(E), 040HB(E)

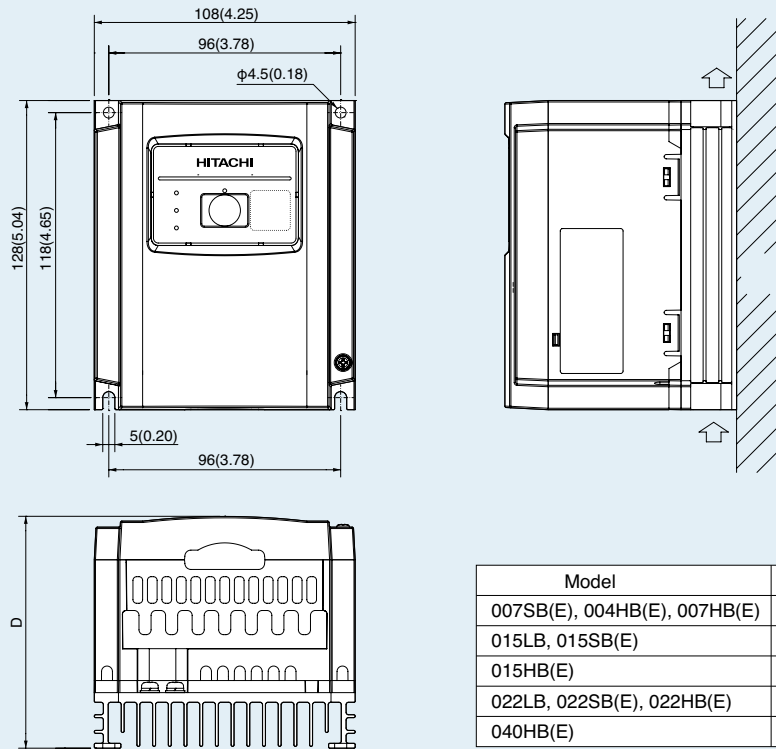

Model	D
007SB(E), 004HB(E), 007HB(E)	96 (3.78)
015LB, 015SB(E)	107 (4.21)
015HB(E)	111 (4.37)
022LB, 022SB(E), 022HB(E)	125 (4.92)
040HB(E)	135 (5.31)

\*007SB(E)/004HB(E):without cooling fan.

# Operation and Programming

The NE-S1 series can be easily operated with the digital operator provided as standard. Change and setting parameter by Keypad (NES1-OP). The digital operator can also be detached and used for remote-control. An operator with copy function is also available as an option.

## <NE-S1 Standard Operator Panel>

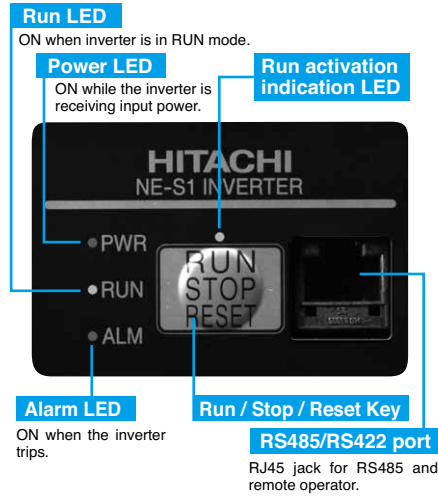

## <Option Operator Panel>

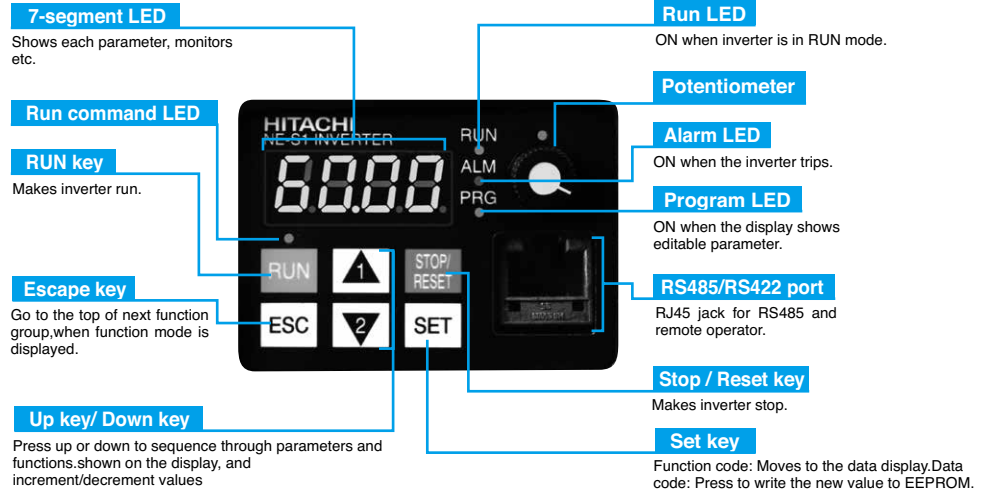

## ● Keypad Navigation Map Single-Digit Edit Mode (At the time of operator use.)

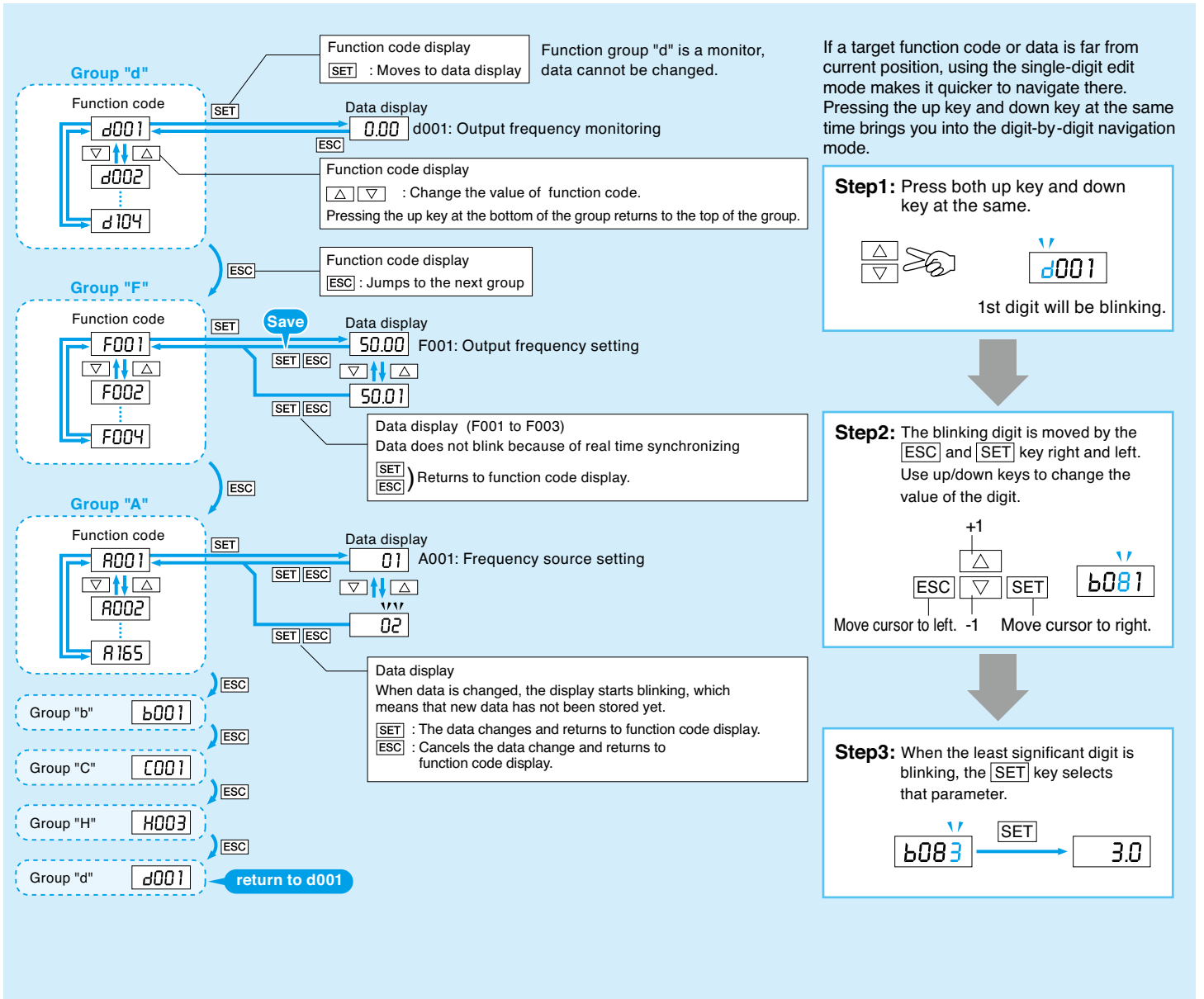



# Operation / Terminal Functions

## Terminal Description

### Terminal Symbol

Terminal Symbol	Terminal Name
L1,L2,N/L3	Main power supply input terminals
U/T1,V/T2,W/T3	Inverter output terminals
+1,+	DC reactor connection terminals
⊕	Ground connection terminal

### Screw Diameter and Terminal Width

Model	Screw diameter (mm)	Terminal width W (mm)
002-004SB(E)	M3.5	7.1
002-007LB		
007-022SB(E)	M4	9.2
015-022LB		
004-040HB(E)		



## Control Circuit Terminals

### Terminal Arrangement

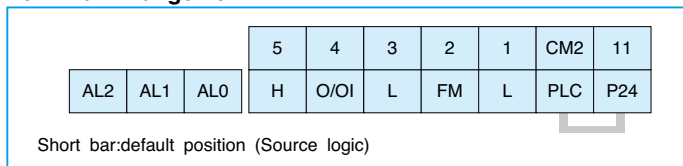

## Terminal Arrangement

### • NES1-002-007LB

R(L1)	S(L2)	T(L3)	P(+)
U(T1)	V(T2)	W(T3)	PD(+1)

### • NES1-002,004SB(E)

L1		N	P(+)
U(T1)	V(T2)	W(T3)	PD(+1)

### • NES1-015,022LB,004-040HB(E)

R(L1)	S(L2)	T(L3)	PD(+1)	P(+)	U(T1)	V(T2)	W(T3)
-------	-------	-------	--------	------	-------	-------	-------

### • NES1-007-022SB(E)

L1		N	PD(+1)	P(+)	U(T1)	V(T2)	W(T3)
----	--	---	--------	------	-------	-------	-------

## Terminal Function



	Terminal name																							
Input/monitor signals	FM	Monitor terminal (frequency, current, etc.)	PWM out put(0 to10V DC, 1mA max.)																					
	L	Common for inputs	-																					
	P24	+24V for logic inputs	24V DC, 30mA (do not short to terminal L)																					
	PLC	Intelligent input common	-																					
	5	Intelligent (programmable) input terminals, selection from: FW(Forward), RV(Reverse), CF1-CF3(Multispeed command), JG(Jogging), DB(External DC braking), SF1-SF3(multispeed bit), SET(Second motor constants setting), 2CH(Second accel./decel.), FRS(Free-run stop), EXT(External trip), USP(Unattended start protection), SFT(Software lock), RS(Reset), STA(3-wire start), STP(3-wire stop), F/R(3-wire fwd./rev.), PID(PID On/Off), PIDC(PID reset), OLR(overload restriction selection), UP/DWN(Remote-controlled accel./decel.), UDC(Remote-controlled data clearing), OPE(Operator control), ADD(Frequency setpoint), F-TM(Force terminal enable),KHC(cumulative power clearance), AHD(analog command holding), HLD(retain output frequency), ROK(permission of run command), DISP (display limitation) or NO(Not selected).																						
	4																							
3																								
2																								
Frequency setting	H	+10V analog reference	10V DC, 10mA max																					
	O/OI	Analog input, voltage/ Analog input, current Switch able by switch but not use them in the same time.	0 to 10V DC, input impedance 10kohm 4 to 20mA DC, input impedance 250ohm																					
	L	Common for inputs	-																					
Output signals	11	Intelligent (programmable) output terminals, selection from: RUN(run signal), FA1(Frequency arrival type 1 -constant speed), FA2(Frequency arrival type 2 -over-frequency), OL(overload advance notice signal), OD(Output deviation for PID control), AL(alarm signal), FA3(Set frequency reached), UV(Under voltage), RNT(Operation time over), ONT(Plug-in time over), DC(Wire brake detect on analog input), FBV(Feedback voltage comparison), NDc(analog voltage input disconnection), LOG1(Logic operation result), LOC(Low Load Detection).	Open collector output L level at operation (ON) 27V DC, 50mA max.																					
	CM2	Common for intelligent output terminals	-																					
Relay output	AL2	Relay contact (alarm output) terminals (programmable, function is selectable same as intelligent output terminals).																						
	AL1																							
	AL0																							
			<table border="1"> <thead> <tr> <th></th> <th>Resistance load</th> <th>Inductive load</th> </tr> </thead> <tbody> <tr> <td>AL1-AL0</td> <td></td> <td></td> </tr> <tr> <td>Maximum contact capacity</td> <td>250V AC, 2A 30V DC, 3A</td> <td>250V AC, 0.2A 30V DC, 0.6A</td> </tr> <tr> <td>Minimum contact capacity</td> <td>100 V AC, 10mA 5 V DC, 100mA</td> <td></td> </tr> <tr> <td>AL2-AL0</td> <td></td> <td></td> </tr> <tr> <td>Maximum contact capacity</td> <td>250V AC, 1A 30V DC, 1A</td> <td>250V AC, 0.2A 30V DC, 0.2A</td> </tr> <tr> <td>Minimum contact capacity</td> <td>100 V AC, 10mA 5 V DC, 100mA</td> <td></td> </tr> </tbody> </table>		Resistance load	Inductive load	AL1-AL0			Maximum contact capacity	250V AC, 2A 30V DC, 3A	250V AC, 0.2A 30V DC, 0.6A	Minimum contact capacity	100 V AC, 10mA 5 V DC, 100mA		AL2-AL0			Maximum contact capacity	250V AC, 1A 30V DC, 1A	250V AC, 0.2A 30V DC, 0.2A	Minimum contact capacity	100 V AC, 10mA 5 V DC, 100mA	
	Resistance load	Inductive load																						
AL1-AL0																								
Maximum contact capacity	250V AC, 2A 30V DC, 3A	250V AC, 0.2A 30V DC, 0.6A																						
Minimum contact capacity	100 V AC, 10mA 5 V DC, 100mA																							
AL2-AL0																								
Maximum contact capacity	250V AC, 1A 30V DC, 1A	250V AC, 0.2A 30V DC, 0.2A																						
Minimum contact capacity	100 V AC, 10mA 5 V DC, 100mA																							

# Function List

The parameter tables in this chapter have a column titled "Run Mode Edit." An Ex mark x means the parameter cannot be edited; a Check mark ✓ means the parameter can be edited. The table example to the right contains two adjacent marks "x ✓". These two marks (that can also be "xx" or "✓ ✓") correspond to low-access or high-access levels to Run Mode edits (note Lo and Hi in column heading). Parameter shown in case "b037" is "00" (Full display).

## Monitoring and Main Profile Parameters

✓: Allowed  
X: Not allowed

Function Code	Name	Range	Default	Unit	Run mode edit	
					Lo	Hi
d001	Output frequency monitoring	0.00 to 99.99/100.0 to 400.0	–	Hz	✓	✓
d002	Output current monitor	0.0 to 6553.5	–	A	–	–
d003	Rotation direction monitor	F(Forward)/o(Stop)/r(Reverse)	–	–	–	–
d004	PID feedback monitoring	0.00 to 99.99 in steps of 0.01 / 100.0 to 999.9 in steps of 0.1 1000. to 9999. in steps of 1 1000 to 9999 in steps of 10 / 100 to 999 in units of 1000	–	–	–	–
d005	Intelligent input terminal status	 e.g. :1,2 : ON 3,4,5 : OFF	–	–	–	–
d006	Intelligent output terminal status	 e.g. :11 : ON AL : OFF	–	–	–	–
d007	Scaled output frequency monitoring	0.00 to 99.99/100.0 to 999.9/1000. to 9999./1000 to 3999	–	–	✓	✓
d013	Output voltage monitor	0.0 to 600.0	–	V	–	–
d014	Power monitoring	0 to 999.9	–	kW	–	–
d015	Cumulative power monitoring	0.0 to 999.9 in steps of 1 kW/h, or the unit set for function "b079" 1000 to 9999 in units of 10 kW/h, or the unit set for function "b079" 100 to 999 in units of 1000 kW/h, or the unit set for function "b079"	–	–	–	–
d016	Cumulative operation RUN time monitoring	0. to 9999. in units of 1 hour 1000 to 9999 in units of 10 hours 100 to 999 in units of 1,000 hours	–	hr	–	–
d017	Cumulative power-on time monitoring	0. to 9999. in units of 1 hour 1000 to 9999 in units of 10 hours 100 to 999 in units of 1,000 hours	–	hr	–	–
d018	Heat sink temperature monitoring	-020. to 120.0	–	°C	–	–
d050	Dual Monitoring	display the monitoring data selected by b160, b161	–	–	–	–
d080	Trip counter	0. to 9999. in units of 1 trip 1000 to 6553 in units of 10 trips	–	time	–	–
d081	Trip monitor 1	Displays trip event information	–	–	–	–
d082	Trip monitor 2		–	–	–	–
d083	Trip monitor 3		–	–	–	–
d084	Trip monitor 4		–	–	–	–
d085	Trip monitor 5		–	–	–	–
d086	Trip monitor 6		–	–	–	–
d090	Warning monitoring	Warning code	–	–	X	X
d102	DC voltage monitoring	0.0 to 999.9/1000.	–	V	X	X
d104	Electronic thermal overload monitoring	0.0 to 100.0	–	%	X	X
F001	Output frequency setting	0.0,start frequency to Maximum frequency(1st/2st) 0.0 to 100.0(%) (PID function on time )	0.00	Hz	✓	✓
F002	Acceleration time (1)	0.00 to 99.99/100.0 to 999.9/1000. to 3600.	10.00	s	✓	✓
F202	Acceleration time (1),2nd motor		10.00	s	✓	✓
F003	Deceleration time (1)	0.00 to 99.99/100.0 to 999.9/1000. to 3600.	10.00	s	✓	✓
F203	Deceleration time (1),2nd motor		10.00	s	✓	✓
F004	Keypad Run key routing	00(Forward)/01(Reverse)	00	–	X	X

## A Group: Standard Functions

✓: Allowed  
X: Not allowed

Function Code	Name	Range	Default	Unit	Run mode edit	
					Lo	Hi
A001	Frequency source setting	00(Keypad potentiometer)/01 (control circuit terminal block)/02 (digital operator)/03 (Modbus)/10 (operation function result)	01	–	X	X
A201	Frequency source setting, 2nd motor	01(control circuit terminal block)/02 (digital operator)/03 (Modbus)	01	–	X	X
A002	Run command source setting		01	–	X	X
A202	Run command source setting, 2nd motor	30.0 to "maximum frequency(1st)" 30.0 to "maximum frequency(2st)"	01	–	X	X
A003	Base frequency setting		60.0	Hz	X	X
A203	Base frequency setting, 2nd motor	"Base frequency(1st)" to 400.0 "Base frequency(2st)" to 400.0	60.0	Hz	X	X
A004	Maximum frequency setting		60.0	Hz	X	X
A204	Maximum frequency setting, 2nd motor	0.00 to 99.99/100.0 to 400.0 0.00 to 99.99/100.0 to 400.0	60.0	Hz	X	X
A011	[O/O] input active range start frequency		0.00	Hz	X	✓
A012	[O/O] input active range end frequency	0 to 100 0 to 100	0.00	Hz	X	✓
A013	Aanalog input active range start voltage		0.	%	X	✓
A014	Aanalog input active range end voltage	00(use set value)/01 (use 0 Hz) 1 to 30 or 31 (500 ms filter ±0.1 Hz with hysteresis)	100.	%	X	✓
A015	Aanalog input start frequency enable		01	–	X	✓
A016	Analog input filter	00(Binary mode)/01(Bit mode)	31.	Spl	X	✓
A019	Multi-speed operation selection		00	–	X	X
A200	Multi-speed frequency setting (0)	0.0/start freq. to maximum freq.	0.00	Hz	✓	✓
A220	Multi-speed frequency (2nd), setting 2nd motor		0.00	Hz	✓	✓
A021	Multi-speed frequency setting (1)		60.00	Hz	✓	✓
A022	Multi-speed frequency setting (2)		40.00	Hz	✓	✓
A023	Multi-speed frequency setting (3)		20.00	Hz	✓	✓
A024	Multi-speed frequency setting (4)		0.00	Hz	✓	✓
A025	Multi-speed frequency setting (5)		0.00	Hz	✓	✓
A026	Multi-speed frequency setting (6)		0.00	Hz	✓	✓
A027	Multi-speed frequency setting (7)		0.00	Hz	✓	✓
A038	Jog frequency		Start frequency to 9.99	6.00	Hz	✓
A039	Jog stop mode	00 (free-running after jogging stops [disabled during operation])/01 (deceleration and stop after jogging stops [disabled during operation])/02 (DC braking after jogging stops [disabled during operation])/03 (free-running after jogging stops [enabled during operation])/04 (deceleration and stop after jogging stops [enabled during operation])/05 (DC braking after jogging stops [enabled during operation])	04	–	X	✓
A041	Torque boost select	00(Manual)/01(Automatic)	00	–	X	X
A241	Torque boost select 2nd motor	00(Manual)/01(Automatic)	00	–	X	X
A042	Manual torque boost value	0.0 to 20.0	1.0	%	✓	✓
A242	Manual torque boost value, 2nd motor	0.0 to 20.0	1.0	%	✓	✓
A043	Manual torque boost frequency adjustment	0.0 to 50.0	5.0	%	✓	✓
A243	Manual torque boost frequency adjustment, 2nd motor	0.0 to 50.0	5.0	%	✓	✓



# Function List

## A Group: Standard Functions

✓: Allowed  
✗: Not allowed

Function Code	Name	Range	Default	Unit	Run mode edit		
					Lo	Hi	
V/f Characteristic	A044	V/f characteristic curve selection	00(VC)/01(VP)/02(free V/f)	00	-	✗	✗
	A244	V/f characteristic curve selection, 2nd motor	00(VC)/0(VP)/02(free V/f)	00	-	✗	✗
	A045	V/f gain	20. to 100.	100.	%	✓	✓
	A245	V/f gain, 2nd motor		100.	%	✓	✓
	A046	Voltage compensation gain for automatic torque boost	0. to 255.	100.	-	✓	✓
	A246	Voltage compensation gain for automatic torque boost, 2nd motor		100.	-	✓	✓
	A047	Slip compensation gain for automatic torque boost		100.	-	✓	✓
A247	Slip compensation gain for automatic torque boost, 2nd motor	0. to 255.	100.	-	✓	✓	
DC braking	A051	DC braking enable	00(Disable)/01(Enable)/02(output freq < [A052])	00	-	✗	✓
	A052	DC braking frequency setting	0.00 to 60.00	0.50	Hz	✗	✓
	A053	DC braking wait time	0.0 to 5.0	0.00	s	✗	✓
	A054	DC braking force during deceleration	0 to 100	50	%	✗	✓
	A055	DC braking time for deceleration	0.0 to 10.0	0.5	s	✗	✓
	A056	DC braking / edge or level detection for [DB] input	00(Edge)/01(Level)	01	-	✗	✓
	A057	DC braking force at start	0. to 100.	0.	%	✗	✓
	A058	DC braking time at start	0.0 to 10.0	0.0	s	✗	✓
	A059	Carrier frequency during DC braking	2.0 to 15.0	2.0	kHz	✗	✓
Frequency Upper/Lower Limit and Jump Frequency	A061	Frequency upper limit setting	0.00/Freq. lower limit setting to maximum freq.	0.00	Hz	✗	✓
	A261	Frequency upper limit setting, 2nd motor	0.00/Freq. lower limit setting (2nd) to maximum freq. (2nd)	0.00	Hz	✗	✓
	A062	Frequency lower limit setting	0.00/Start freq. to freq. upper limit setting	0.00	Hz	✗	✓
	A262	Frequency lower limit setting, 2nd motor	0.00/Start freq. (2nd) to freq. upper limit setting (2nd)	0.00	Hz	✗	✓
	A063	Jump freq. (center) 1	0.00 to 99.99/100.0 to 400.0	0.00	Hz	✗	✓
	A064	Jump (hysteresis) frequency setting 1	0.00 to 10.00	0.50	Hz	✗	✓
	A065	Jump freq. (center) 2	0.00 to 99.99/100.0 to 400.0	0.00	Hz	✗	✓
	A066	Jump (hysteresis) frequency setting 2	0.00 to 10.00	0.50	Hz	✗	✓
	A067	Jump freq. (center) 3	0.00 to 99.99/100.0 to 400.0	0.00	Hz	✗	✓
	A068	Jump (hysteresis) frequency setting 3PID Enable	0.00 to 10.00	0.50	Hz	✗	✓
PID Control	A069	Acceleration hold frequency	0.00 to 99.99/100.0 to 400.0	0.00	Hz	✓	✓
	A070	Acceleration hold time setting	0.0 to 60.0	0.0	s	✗	✓
	A071	PID Enable	00(Disable)/01(Enable)/02(Enabling inverted data output)	00	-	✗	✓
	A072	PID proportional gain	0.00 to 25.00	1.00	-	✓	✓
	A073	PID integral time constant	0.0 to 999.9/1000. to 3600.	1.0	s	✓	✓
	A074	PID derivative time constant	0.00 to 99.99/100.0	0.00	s	✓	✓
	A075	PV scale conversion	0.01 to 99.99	1.00	-	✗	✓
	A076	PV source setting	01 (Analog1)/02(Modbus)/10 (operation result output)	01	-	✗	✓
AVR function	A077	Reverse PID action	00(OFF)/01(ON)	00	-	✗	✓
	A078	PID output limit	0.0 to 100.0	0.0	%	✗	✓
	A081	AVR function select	00 (always on)/ 01 (always off)/ 02 (off during deceleration)	02	-	✗	✗
	A281	AVR function select, 2nd motor		02	-	✗	✗
	A082	AVR voltage select	200V class: 200/215/220/230/240, 400V class:380/400/415/440/480	200/400	V	✗	✗
	A282	AVR voltage select, 2nd motor		200/400	V	✗	✗
	A083	AVR filter time constant	0.000 to 1.000	0.030	s	✗	✓
A084	AVR deceleration gain	50. to 200.	100.	%	✓	✓	
Automatic Energy Saving	A085	Operation mode selection	00(Normal)/01(Energy-saver)	00	-	✗	✗
	A086	Energy saving mode tuning	0.0 to 100.0	50.0	%	✓	✓
Operation mode and acc./dec. function	A092	Acceleration time (2)	0.00 to 99.99/100.0 to 999.9/1000. to 3600.	10.00	s	✓	✓
	A292	Acceleration time (2),2nd motor		10.00	s	✓	✓
	A093	Deceleration time (2)	0.00 to 99.99/100.0 to 999.9/1000. to 3600.	10.00	s	✓	✓
	A293	Deceleration time (2),2nd motor		10.00	s	✓	✓
	A094	Select method to switch to Acc2/Dec2 profile	00 (switching by 2CH terminal)/ 01 (switching by setting)/ 02 (Forward and reverse)	00	-	✗	✗
	A294	Select method to switch to Acc2/Dec2 profile, 2nd motor	00 (switching by 2CH terminal)/ 01 (switching by setting)/ 02 (Forward and reverse)	00	-	✗	✗
	A095	Acc1 to Acc2 frequency transition point	0.00 to 99.99/100.0 to 400.0	0.00	Hz	✗	✗
	A295	Acc1 to Acc2 frequency transition point, 2nd motor		0.00	Hz	✗	✗
	A096	Dec1 to Dec2 frequency transition point	0.00 to 99.99/100.0 to 400.0	0.00	Hz	✗	✗
	A296	Dec1 to Dec2 frequency transition point, 2nd motor		0.00	Hz	✗	✗
	A097	Acceleration curve selection	00(Linear)/01(S-curve)/ 02 (U curve)/ 03 (inverted-U curve)	00	-	✗	✗
	A098	Deceleration curve selection	00(Linear)/01(S-curve)/ 02 (U curve)/ 03 (inverted-U curve)	00	-	✗	✗
A131	Acceleration curve constant setting (for S, U, Inverse U)	1 to 10	2	-	✗	✓	
A132	Deceleration curve constant setting (for S, U, Inverse U)	1 to 10	2	-	✗	✓	
Frequency calculation	A141	A input select for calculate function	00(Digital operator)/01(Keypad potentiometer)	00	-	✗	✓
	A142	B input select for calculate function	02(input via Analog1)/04 (external communication)	02	-	✗	✓
	A143	Calculation symbol	00(A141+A142)/01(A141-A142)/02(A141×A142)	00	-	✗	✓
	A145	ADD frequency	0.00 to 99.99/100.0 to 400.0	0.00	Hz	✗	✓
	A146	ADD direction select	00 (frequency command + A145)/ 01(frequency command - A145)	00	-	✗	✓
	A154	Deceleration hold frequency	0.00 to 99.99/100.0 to 400.0	0.00	Hz	✗	✓
	A155	Deceleration hold time setting	0.0 to 60.0	0	s	✗	✓
	A156	PID sleep function action threshold	0.00 to 99.99/100.0 to 400.0	0.00	Hz	✗	✓
	A157	PID sleep function action delay time	0.0 to 25.5	0.0	s	✗	✓
	A158	PID sleep function return threshold	0.00 to 99.99/100.0 to 400.0	0.00	Hz	✗	✓
	A161	[VR] input active range start frequency	0.00 to 99.99/100.0 to 400.0	0.00	Hz	✓	✓
	A162	[VR] input active range end frequency	0.00 to 99.99/100.0 to 400.0	0.00	Hz	✓	✓
	A163	[VR] input active range start %	0. to [VR] input active range end	0.	%	✓	✓
A164	[VR] input active range end %	[VR] input active range start to 100.	100.	%	✓	✓	
A165	Option operator input start frequency enable	00(A161)/01(0Hz)	01	-	✗	✓	

## b Group: Fine-tuning Functions

✓: Allowed  
✗: Not allowed

Function Code	Name	Range	Default	Unit	Run mode edit		
					Lo	Hi	
Restart after instantaneous power failure	b001	Selection of automatic restart mode	00 (tripping)/ 01 (starting with 0 Hz)/ 02 (starting with matching frequency)/ 03 (tripping after deceleration and stopping with matching frequency)	00	-	✗	✓
	b002	Allowable under-voltage power failure time	0.3 to 25.0	1.0	s	✗	✓
	b003	Retry wait time before motor restart	0.3 to 100.0	1.0	s	✗	✓
	b004	Under-voltage trip alarm enable	00 (OFF)/ 01 (ON)/ 02 (disabling during stopping and decelerating to stop)	00	-	✗	✓
	b005	Under-voltage trip events	00 (16 times)/ 01 (No limit)	00	-	✗	✓
	b007	Restart frequency threshold	0.00 to 400.00	0.50	Hz	✗	✓
	b008	Selection of retry after tripping	00 (tripping)/ 01 (starting with 0 Hz)/ 02 (starting with matching frequency)/ 03 (tripping after deceleration and stopping with matching frequency)	00	-	✗	✓
	b010	Selection of retry count after undervoltage	1 to 3	3	times	✗	✓
	b011	Start frequency to be used in case of frequency pull-in restart	0.3 to 100.0	1.0	s	✗	✓

# Function List

## b Group: Fine-tuning Functions

[ ✓: Allowed  
X: Not allowed ]

Function Code	Name	Range	Default	Unit	Run mode edit			
					Lo	Hi		
Electronic thermal	b012	Electronic thermal setting	0.20 × Rated current to 1.00 × Rated current	Rated current	A	X	✓	
	b212	Electronic thermal setting, 2nd motor		Rated current	A	X	✓	
	b013	Electronic thermal characteristic	00 (reduced-torque characteristic)/ 01 (constant-torque characteristic)/ 02 (free setting)	01	—	X	✓	
	b213	Electronic thermal characteristic, 2nd motor		01	—	X	✓	
	b015	Free setting, electronic thermal frequency (1)	0 to Free setting, electronic thermal frequency (2)	0.0	Hz	X	✓	
	b016	Free setting electronic thermal ~current1	0.00 to inverter rated current Amps	0.0	A	X	✓	
	b017	Free setting, electronic thermal frequency (2)	Free setting, electronic thermal frequency (1) to Free setting, electronic thermal frequency (3)	0.0	Hz	X	✓	
	b018	Free setting electronic thermal ~current2	0.00 to inverter rated current Amps	0.0	A	X	✓	
	b019	Free setting electronic thermal ~freq.3	Free setting, electronic thermal frequency (2) to 400.0	0.0	Hz	X	✓	
	b020	Free setting electronic thermal ~current3	0.00 to inverter rated current Amps	0.0	A	X	✓	
Overload restriction	b021	Overload restriction operation mode	00(Disable)/01(Enable)/02(Enable for during acceleration)	01	—	X	✓	
	b221	Overload restriction operation mode, 2nd motor		01	—	X	✓	
	b022	Overload restriction setting		150% of Rated current	A	X	✓	
	b222	Overload restriction setting, 2nd motor	0.20 × Rated current to 2.00 × Rated current		A	X	✓	
	b023	Deceleration rate at overload restriction	0.1 to 999.9/1000. to 3000.	1.0	s	X	✓	
	b223	Deceleration rate at overload restriction, 2nd motor		1.0	s	X	✓	
	b024	Overload restriction operation mode 2	00 (disabling)/ 01 (enabling during acceleration and constant-speed operation)/ 02 (enabling during constant-speed operation)	01	—	X	✓	
	b025	Overload restriction level 2 setting	0.20 × rated current to 2.00×rated current	150% of Rated current	A	X	✓	
	b026	Deceleration rate 2 at overload restriction	0.1 to 999.9/1000. to 3000.	1.0	s	X	✓	
	b027	OC suppression selection	00 (OFF)/ 01 (ON)	01	—	X	✓	
Lock	b028	Current level of active freq. matching restart setting	0.20 × rated current to 2.00 × rated current	Rated current	A	X	✓	
	b029	Deceleration rate of active freq. matching	0.1 to 999.9/1000. to 3000.	0.5	s	X	✓	
	b030	Start freq. to be used in case of active freq. Matching restart	00 (frequency at the last shutoff)/ 01 (maximum frequency)/ 02 (set frequency)	00	—	X	✓	
	b031	Software lock mode selection	00(SFT) input blocks all edits/01(SFT) input blocks edits except F001 and Multispeed parameters/02(No access to edits)/03(No access to edits except F001 and Multi-speed parameters)/10(High-level access,including b031)	01	—	X	✓	
	Others	b034	Run/power ON warning time	0. (Disabling the signal output) /1. to 9999. in units of 10 hours 1000 to 6553 in units of 100 hours	0.	Hrs	X	✓
		b035	Rotation direction restriction	00( Enable for both dir)/ 01 (Enable for forward only)/ 02 (Enable for reverse only)	00	—	X	X
		b036	Reduced voltage start selection	0 (minimum reduced voltage start time) to 255 (maximum reduced voltage start time)	3	—	X	✓
		b037	Function code display restriction	0 (full display), 1 (function-specific display) , 3 (data comparison display), 4 (basicdisplay), 5(monitor display)	00	—	X	✓
		b038	Initial display selection	000(Func. code that SET key pressed last displayed.) / 001 to 060(d001 to d060 displayed) / 201(F001displayed) / 202(B display of LCD operator (In case of Digital operator, same 000 setting)	001	—	X	✓
		b050	Selection of the non stop operation	00(Disable)/ 01 (enabling)/ 02 (nonstop operation at momentary power failure (no restoration))/03 (nonstop operation at momentary power failure (restoration to be done))	00	—	X	X
b051		DC bus voltage trigger level of ctrl. decel.	200V class:0.0 to 400.0, 400V class:0.0 to 800.0	220.0/440.0	V	X	X	
b052		Over-voltage threshold of ctrl. decel.	200V class:0.0 to 400.0, 400V class:0.0 to 800.0	360.0/720.0	V	X	X	
b053		Deceleration time of ctrl. decel.	0.01 to 300.0	1.00	s	X	X	
b054		Frequency width of quick deceleration setting	0.00 to 10.00	0.00	Hz	X	X	
b060		Maximum-limit level of window comparators	0 to 100	100.	%	✓	✓	
b061		Minimum-limit level of window comparators	0 to 100	0.	%	✓	✓	
b062		Hysteresis width of window comparators	0 to 10	0.	%	✓	✓	
b070		Operation level at O/OI disconnection	0. to 100., or "no" (ignore)	no	—	X	✓	
b078		Watt-hour clearance	00(OFF)/01(CLR)(press STR then clear)	00	—	✓	✓	
b079		Watt-hour display gain	1. to1000.	1.	—	✓	✓	
b082		Start frequency adjustment	0.01 to 9.99	0.50	Hz	X	✓	
b083		Carrier frequency setting	2.0 to 15.0 *1	2.0	kHz	X	✓	
b084		Initialization mode (parameters or trip history)	00(disabling)/ 01 (clearing the trip history)/ 02 (initializing the data)/ 03 (clearing the trip history and initializing the data)	00	—	X	X	
b085		Country code for initialization	00 (Mode1)/ 01 (Mode2)	00	—	X	X	
b086		Frequency scaling conversion factor	0.01 to 99.99	1.00	—	✓	✓	
b087		STOP key enable	00:ON(Enable)/01:OFF(Disable)/02:Only RESET(Disable for stop)	00	—	X	✓	
b088		Restart mode after FRS	00(Restart from 0Hz)/01(Restart with frequency detection)	00	—	X	✓	
b089		Automatic carrier frequency reduction	00(disabling)/ 01(enabling( output current controlled))/ 02(enabling( fin temperature controlled))	00	—	X	X	
b091		Stop mode selection	00(Deceleration and stop)/01(Free-run stop)	00	—	X	✓	
b094		Initialization target data setting	00(All parameters)/01(All parameters except in/output terminals and communication)	00	—	X	✓	
b100		Free-setting V/F freq. (1)	0. to b102	0.	Hz	X	X	
b101		Free-setting V/F volt. (1)	200V class:0.0 to 300.0, 400V class:0.0 to 600.0	0.0	V	X	X	
b102		Free-setting V/F freq. (2)	b100 to b104	0.	Hz	X	X	
b103		Free-setting V/F volt. (2)	200V class:0.0 to 300.0, 400V class:0.0 to 600.0	0.0	V	X	X	
b104	Free-setting V/F freq. (3)	b102 to b106	0.	Hz	X	X		
b105	Free-setting V/F volt. (3)	200V class:0.0 to 300.0, 400V class:0.0 to 600.0	0.0	V	X	X		
b106	Free-setting V/F freq. (4)	b104 to b108	0.	Hz	X	X		
b107	Free-setting V/F volt. (4)	200V class:0.0 to 300.0, 400V class:0.0 to 600.0	0.0	V	X	X		
b108	Free-setting V/F freq. (5)	b106 to b110	0.0	Hz	X	X		
b109	Free-setting V/F volt. (5)	200V class:0.0 to 300.0, 400V class:0.0 to 600.0	0	V	X	X		
b110	Free-setting V/F freq. (6)	b108 to b112	0.	Hz	X	X		
b111	Free-setting V/F volt. (6)	200V class:0.0 to 300.0, 400V class:0.0 to 600.0	0.0	V	X	X		
b112	Free-setting V/F freq. (7)	b110 to 400	0.	Hz	X	X		
b113	Free-setting V/F volt. (7)	200V class:0.0 to 300.0, 400V class:0.0 to 600.0	0.0	V	X	X		
b130	Over-voltage LADSTOP enable	00 (OFF)/ 01 (V-count)/ 02 (Accel)/ 03(Acc/Dcc)	00	—	X	✓		
b131	Decel. overvolt. suppress level	200V class:330. to 390. , 400V class:660. to 780.	360/720	V	X	✓		
b132	DC bus AVR constant setting	0.10 to 30.00	1.00	s	X	✓		
b133	DC bus AVR for decel. Proportional-gain	0.00 to 5.00	0.20	—	✓	✓		
b134	DC bus AVR for decel. Integral-time	0.0 to 150.0	1.0	s	✓	✓		
b150	Panel Display selection	001 to 050	001	—	✓	✓		
b160	1st data of d050	001 to 018	001	—	✓	✓		
b161	2nd parameter of Double Monitor	001 to 018	002	—	✓	✓		
b163	Data change mode selection of d001 and d007	00 (OFF)/ 01 (ON)	01	—	✓	✓		
b164	Automatic return to the initial display	00 (OFF)/ 01 (ON)	00	—	✓	✓		
b165	Ex. operator com. loss action	00 (trip)/01 (trip after deceleration to a stop)/02 (Ignore)/03 (coasting (FRS))/ 04 (decelerates to a stop)	02	—	✓	✓		
b166	Data Read/Write select	00 (Read/Write OK)/01 (Protected)	00	—	X	✓		
b180	Initialization trigger	00 (initialization disable)/01 (perform initialization)	00	—	X	X		

Note 1: Carrier derating required for ambient temperature higher than 40°C(022SB:temperature higher than 30°C), no freezing. When attach option FFM, in 015/022SB the derating becomes needless.

# Function List

## C Group: Intelligent Terminal Functions

✓: Allowed  
✗: Not allowed

Function Code	Name	Range	Default	Unit	Run mode edit		
					Lo	Hi	
Intelligent input terminal	C001	Terminal [1] function	00(FW:Forward), 01(RV:Reverse), 02-04(CF1-CF3:Multispeed command), 06(JG:Jogging), 07(DB:External DC braking), 08(SET:Second motor constants setting), 09(2CH:Second accel./decel.), 11(FRS:Free-run stop), 12(EXT:External trip), 13(USP:Unattended start protection), 15(SFT:Software lock), 18(RS:Reset), 20(STA:3-wire start), 21(STP:3-wire stop), 22(F/R:3-wire fwd./rev.), 23(PID:PID On/Off), 24(PIDC:PID reset), 27(UP:Remote-controlled accel.), 28(DWN:Remote-controlled decel.), 29(UDC:Remote-controlled data clearing), 31(OPE:Operator control), 32-34(SF1-SF3: multispeed bit), 39 (OLR: overload restriction selection), 50(ADD: Frequency setpoint), 51(F-TM: Force terminal enable), 53(S-ST: Special-Set (select) 2nd Motor Data), 65 (AHD: analog command holding), 83 (HLD: retain output frequency), 84 (ROK: permission of run command), 86 (DISP: display limitation),255(NO:Not selected),	00	-	✗	✓
	C002	Terminal [2] function		01	-	✗	✓
	C003	Terminal [3] function		02	-	✗	✓
	C004	Terminal [4] function		03	-	✗	✓
	C005	Terminal [5] function		18	-	✗	✓
C011- C015	Terminal [1] to [5] active state	00(NO)/01(NC)	00	-	✗	✓	
Intelligent input terminal	C021	Terminal [11] function	00(RUN:run signal), 01(FA1:Frequency arrival type 1 - constant speed), 02(FA2:Frequency arrival type 2 - over-frequency), 03(OL:overload advance notice signal), 04(OD:Output deviation for PID control), 05(AL:alarm signal), 06(DC:Wire brake detect on analog input), 09(LOG: Logic operation result), 11 (RNT: run time expired), 12 (ONT: power ON time expired), 13 (THM: thermal warning), 21 (ZS: 0Hz detection), 27 (ODc: Analog input disconnect detection), 31 (FBV: PID second stage output), 32 (NDC: Network disconnect detection), 33 (LOG1: Logic output function 1), 41 (FR: Starting contact signal), 42 (OHF: Heat sink overheat warning), 50 (IRDY:Inverter ready), 51 (FWR:Forward rotation), 52 (RVR:Reverse rotation), 53 (MJA:Major failure), 54 (WCO: Window comparator), 58(FREF: Frequency command source), 59(REF: Run command source), 60(SETM:Second motor in operation),255(NO: Not selected)	01	-	✗	✓
	C026	Alarm relay function		05	-	✗	✓
	C027	FM signal selection (Pulse/PWM output)	00 (output frequency), 01 (output current), 03 (digital output frequency), 04 (output voltage), 05 (input power), 06 (electronic thermal overload), 07 (LAD frequency), 08 (digital current monitoring), 10 (heat sink temperature)	07	-	✗	✓
	C030	Digital current monitor reference value	0.20 × rated current to 2.00 × rated current	Rated current	A	✓	✓
	C031	Terminal [11] active state	00(NO)/01(NC)	00	-	✗	✓
	C036	Alarm relay active state	00(NO)/01(NC)	01	-	✗	✓
	C038	Output mode of low load detection signal	00 (output during acceleration/deceleration and constant-speed operation)/ 01 (output only during constant-speed operation)	01	-	✗	✓
	C039	Low load detection level	0.00 to 2.00 × Rated current to 2.00 × rated current	Rated current	A	✓	✓
	C040	Output mode of overload warning	00 (output during acceleration/deceleration and constant-speed operation)/ 01 (output only during constant-speed operation)	01	-	✗	✓
	C041	Overload level setting		115% of Rated current	A	✓	✓
	C241	Overload level setting, 2nd motor	0.00 × Rated current to 2.00 × Rated current		A	✓	✓
	C042	Frequency arrival setting for acceleration	0.00 to 99.99/100.0 to 400.0	0.00	Hz	✗	✓
	C043	Frequency arrival setting for deceleration	0.00 to 99.99/100.0 to 400.0	0.00	Hz	✗	✓
	C044	PID deviation level setting	0.0 to 100.0	3.0	%	✗	✓
	C052	Feedback comparison upper level	0.0 to 100.0	100.0	%	✗	✓
	C053	Feedback comparison lower level	0.0 to 100.0	0.0	%	✗	✓
	C061	Electronic thermal warning level	0. to 100.	90.	%	✗	✓
	C063	Zero speed detection level	0.00 to 99.99/100.0	0.00	Hz	✗	✓
	C064	Heat sink overheat warning	0. to 110.	100.	°C	✗	✓
	Serial communication	C070	SELECTION OF OPE/MODBUS	00(OPE)/01 (Modbus)	00	-	✗
C071		Communication speed	04(4800bps)/ 05(9600bps)/ 06(19.2kpbs)/07(38.4kpbs)	05	bps	✗	✓
C072		Node allocation	1 to 247	1.	-	✗	✓
C074		Communication parity selection	00(No parity)/01(Even parity)/02(Odd parity)	00	-	✗	✓
C075		Communication stop bit selection	01(1-bit)/02(2-bit)	01	bit	✗	✓
C076		Communication error mode	00(Trip)/01(Tripping after decelerating and stopping the motor)/02(Disable)/ 03(FRS)/04(Deceleration stop)	02	-	✗	✓
C077		Communication error time-out	0.00(disabled)/0.01 to 99.99	0.00	s	✗	✓
C078		Communication wait time	0. to 1000.	0.	ms	✗	✓
Analog meter setting	C081	O/OI input span calibration	0.0 to 200.0	100.0	%	✓	✓
Others	C091	Debug mode enable	00(MD0)/01 (MD1)	00	-	-	-
	C101	Up/Down memory mode selection	00 (not storing the frequency data)/ 01 (storing the frequency data)	00	-	✗	✓
	C102	Reset mode selection	00(Cancel trip state at input signal ON transition)/ 01(Cancel trip state at signal OFF transition)/02(Cancel trip state at input signal ON transition)	00	-	✓	✓
	C103	Restart mode after reset	00 (starting with 0 Hz)/ 01 (restarting with active matching frequency)	00	-	✗	✓
	C104	UP/DWN clear: terminal input mode selection	00(0Hz)/01(Flash data when power supply is turned on)	00	-	✗	✓
	C105	FM gain adjustment	50. to 200.	100.	%	✓	✓
	C130	Output 11 on-delay time	0.0 to 100.0	0.0	s	✗	✓
	C131	Output 11 off-delay time	0.0 to 100.0	0.0	s	✗	✓
	C140	Output RY on-delay time	0.0 to 100.0	0.0	s	✗	✓
	C141	Output RY off-delay time	0.0 to 100.0	0.0	s	✗	✓
	C142	Logical output signal 1 selection 1	Same as the settings of C021 to C026 (except those of LOG1 to LOG3 & OPO , no)	00	-	✗	✗
	C143	Logical output signal 1 selection 2	Same as the settings of C021 to C026 (except those of LOG1 to LOG3 & OPO , no)	00	-	✗	✗
	C144	Logical output signal 1 operator selection	00(AND)/01(OR)/02(XOR)	00	-	✗	✓
	C151	Button sensitivity selection	0 to 250 / no	10	-	✗	✓
	C152	Scroll sensitivity selection	1 to 20	10	-	✗	✓
	C155	Ground fault set	00(OFF) / 01(ON)	01	-	✗	✓
	C157	Out phase-loss set	00(OFF) / 01(ON)	00	-	✗	✓
	C160	Response time of intelligent input terminal 1	0. to 200. (x2ms)	1.	-	✗	✓
	C161	Response time of intelligent input terminal 2	0. to 200. (x2ms)	1.	-	✗	✓
	C162	Response time of intelligent input terminal 3	0. to 200. (x2ms)	1.	-	✗	✓
C163	Response time of intelligent input terminal 4	0. to 200. (x2ms)	1.	-	✗	✓	
C164	Response time of intelligent input terminal 5	0. to 200. (x2ms)	1.	-	✗	✓	
C169	Multistage speed determination time	0. to 200. (x10ms)	0.	ms	✓	✓	

## H Group: Motor Constants Functions

✓: Allowed  
✗: Not allowed

Function Code	Name	Range	Default	Unit	Run mode edit			
					Lo	Hi		
Motor constants and gain	H003	Motor capacity, 1st motor	Factory set	kW	✗	✗		
	H203	Motor capacity, 2nd motor			✗	✗		
	H004	Motor poles setting, 1st motor			4	poles	✗	✗
	H204	Motor poles setting, 2nd motor			4	poles	✗	✗
	H006	Motor stabilization constant			100.	-	✓	✓
	H206	Motor stabilization constant, 2nd motor			100.	-	✓	✓



# Protective Functions

## Error Codes (Standard)

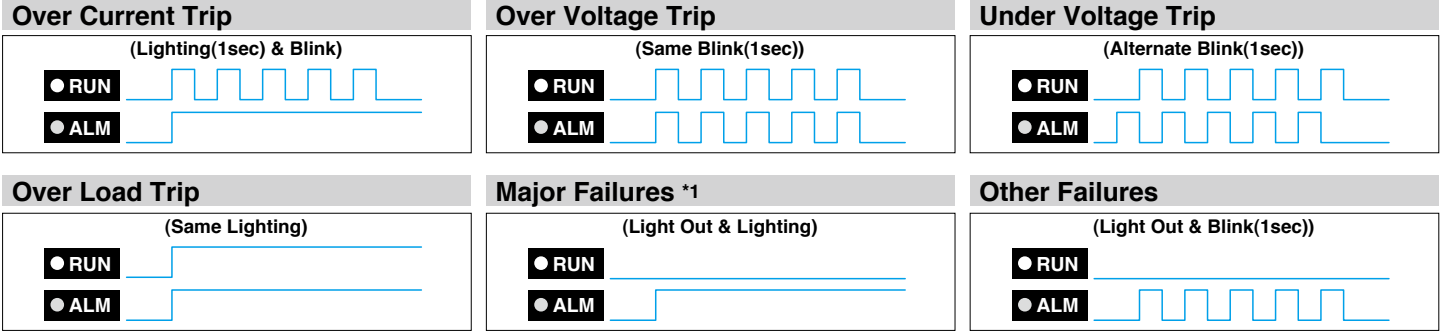

\*1 The Major fault: When a memory error, CPU error and Ground fault.

## Error Codes (Operator)

Name	Cause(s)	Display on digital operator	
Over current	The inverter output was short-circuited, or the motor shaft is locked or has a heavy load. These conditions cause excessive current for the inverter, so the inverter output is turned OFF.	While at constant speed	E01
		During deceleration	E02
		During acceleration	E03
		Others	E04
Overload protection *1	When a motor overload is detected by the electronic thermal function, the inverter trips and turns OFF its output.	E05	
Over voltage protection	When the DC bus voltage exceeds a threshold, due to regenerative energy from the motor.	E07	
Memory error *2,3	When the built-in memory has problems due to noise or excessive temperature, the inverter trips and turns OFF its output to the motor.	E08	
Under-voltage error	A decrease of internal DC bus voltage below a threshold results in a control circuit fault. This condition can also generate excessive motor heat or cause low torque. The inverter trips and turns OFF its output.	E09	
Current detection error	If an error occurs in the internal current detection system, the inverter will shut off its output and display the error code.	E10	
CPU error	A malfunction in the built-in CPU has occurred, so the inverter trips and turns OFF its output to the motor.	E11	
External trip	A signal on an intelligent input terminal configured as EXT has occurred. The inverter trips and turns OFF the output to the motor.	E12	
USP *4	When the Unattended Start Protection (USP) is enabled, an error occurred when power is applied while a Run signal is present. The inverter trips and does not go into Run Mode until the error is cleared.	E13	
Ground fault *5	The inverter is protected by the detection of ground faults between the inverter output and the motor during powerup tests. This feature protects the inverter, and does not protect humans.	E14	
Input over-voltage	When the input voltage is higher than the specified value, it is detected 100 seconds after powerup and the inverter trips and turns OFF its output.	E15	
Inverter thermal detection system error	When the cooling fin thermal sensor in the inverter detect disconnection etc, inverter trips.	E19	
Inverter thermal trip	When the inverter internal temperature is above the threshold, the thermal sensor in the inverter module detects the excessive temperature of the power devices and trips, turning the inverter output OFF.	E21	
Driver error	An internal inverter error has occurred at the safety protection circuit between the CPU and main driver unit. Excessive electrical noise may be the cause. The inverter has turned OFF the IGBT module output.	E30	
Output phase loss protection	Output Phase Loss Logic Detection (There are undetectable terms of use.)	E34	
Low-speed overload protection	If overload occurs during the motor operation at a very low speed, the inverter will detect the overload and shut off the inverter output.	E38	
Operator connection failure	When the connection between inverter and operator keypad failed, inverter trips and displays the error code.	E40	
Communications error	The inverter's watchdog timer for the communications network has timed out.	E41	

Note 1: Reset operations acceptable 10 seconds after the trip. Note 2: If an memory error (E08) occurs, be sure to confirm the parameter data values are still correct.  
 Note 3: Memory error may occur at power-on after shutting down the power while copying data with remote operator or initializing data. Shut down the power after completing copy or initialization.  
 Note 4: USP error occurs at resetting trip after under-voltage error (E09) if USP is enabled. Reset once more to recover.  
 Note 5: Ground fault error (E14) cannot be released with resetting. Shut the power and check wiring.  
 Note 6: When error E08 error, it may be required to perform initialization.

## How to access the details about the present fault

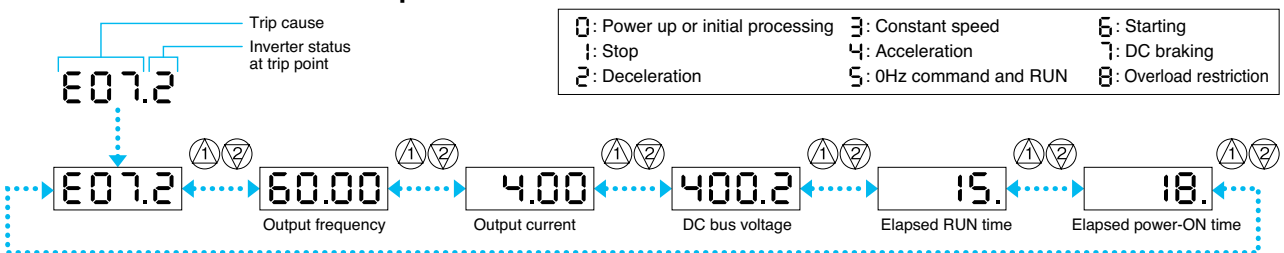

Note: Indicated inverter status could be different from actual inverter behavior. (e.g. When PID operation or frequency given by analog signal, although it seems constant speed, acceleration and deceleration could be repeated in very short cycle.)

# Connecting Diagram

## Source type logic

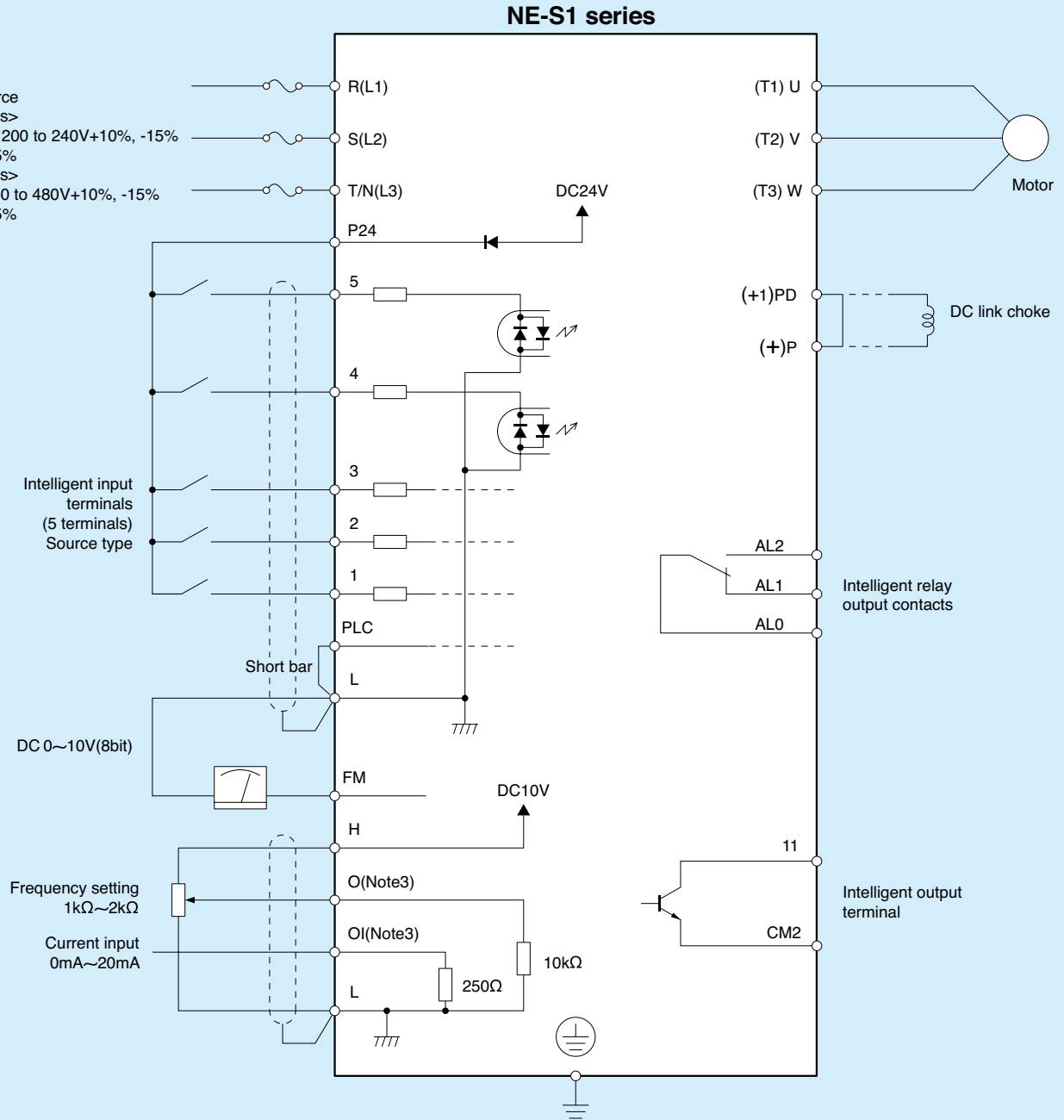

Note 1: Common terminals are depend on logic.

Terminal	1,2,3,4,5	H,O/OI	11
Common	P24	L	CM2

Note 2: Please choose proper inverter input voltage rating.

Note 3: Voltage input: 0 to 10V and current input: 0 to 20mA  
 (change parameter to move 4 to 20mA current input).  
 O and OI is common input terminal (O / OI terminal) change voltage / current input by switch.

# Connecting Diagram

## Sink type logic (default)

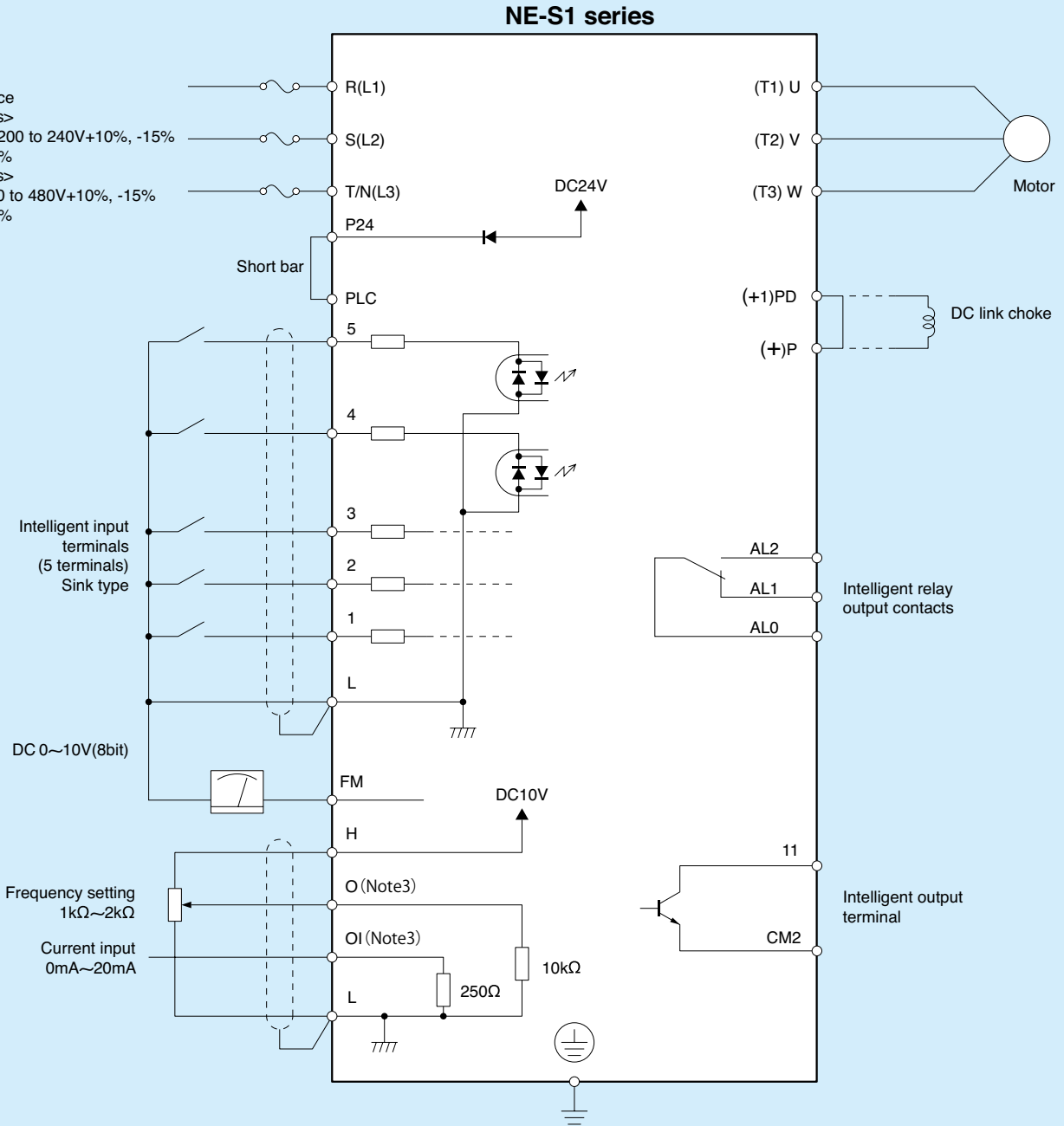

Note 1: Common terminals are depend on logic.

Terminal	1,2,3,4,5,H,O/OI	11
Common	L	CM2

Note 2: Please choose proper inverter input voltage rating.

Note 3: Voltage input: 0 to 10V and current input: 0 to 20mA  
 (change parameter to move 4 to 20mA current input).

O and OI is common input terminal (O / OI terminal) change voltage / current input by switch.



# Wiring and Accessories

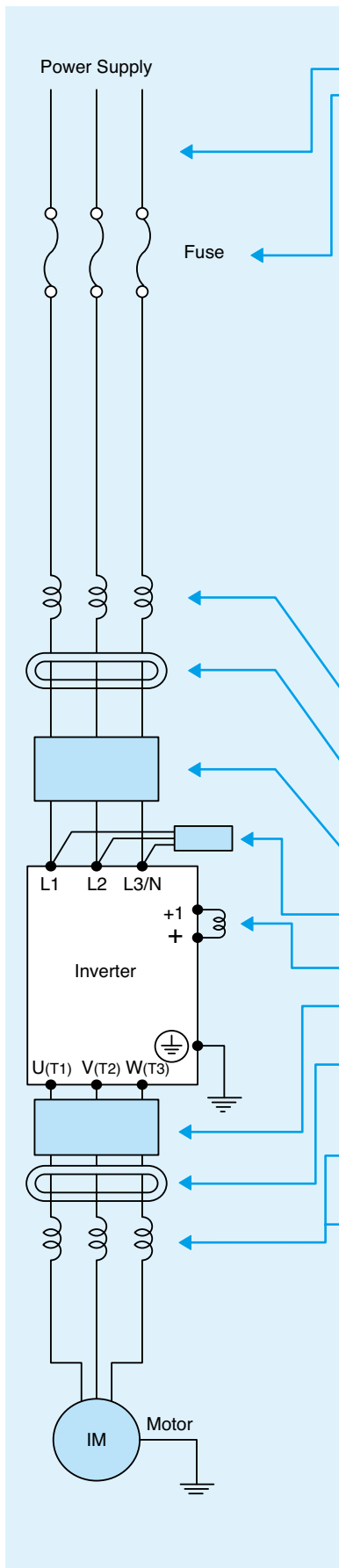

Input Voltage	Motor Output (kW(HP))	Model	Wiring		Signal Lines	Fuse		Circuit Breaker	
			Power Lines			Type	Rated	Type	Rated
			AWG	mm <sup>2</sup>					
1-phase 200V	0.2(1/4)	NES1-002SB(E)	AWG14	2.0	0.75mm <sup>2</sup> shielded wire	Class □, CC,G or T	10A	Inverse Time	15A
	0.4(1/2)	NES1-004SB(E)	AWG14	2.0					
	0.75(1)	NES1-007SB(E)	AWG14	2.0					
	1.5(2)	NES1-015SB(E)	AWG10	5.5					
	2.2(3)	NES1-022SB(E)	AWG10	5.5					
3-phase 200V	0.2(1/4)	NES1-002LB	AWG16	1.25			10A	15A	
	0.4(1/2)	NES1-004LB	AWG16	1.25					
	0.75(1)	NES1-007LB	AWG16	1.25					
	1.5(2)	NES1-015LB	AWG14	2.0					
	2.2(3)	NES1-022LB	AWG14	2.0					
3-phase 400V	0.4 (1/2)	NES1-004HB(E)	AWG16	1.25	15A	—			
	0.75(1)	NES1-007HB(E)	AWG16	1.25					
	1.5(2)	NES1-015HB(E)	AWG16	1.25					
	2.2(3)	NES1-022HB(E)	AWG14	2					
	4.0(5)	NES1-040HB(E)	AWG14	2					

Note 1: Field wiring connection must be made by a UL and c-UL listed closed-loop terminal connector sized for the wire gauge involved.

Connector must be fixed using the crimping tool specified by the connector manufacturer.

Note 2: Be sure to use large wire gauges for power wiring if the distance exceeds 20m (66ft).

Note 3: Use 0.75mm<sup>2</sup> /18 AWG wire for the relay terminals (AL0, AL1 and AL2) signal wire.

Name	Function
Input side AC reactor (Note 4)	This is useful in suppressing harmonics induced on the power supplylines, or when the main power voltage imbalance exceeds 3% (and power source capacity is more than 500kVA), or to smooth out line fluctuations. It also improves the power factor.
Radio noise filter	Electrical noise interference may occur on nearby equipment such as a radio receiver. This magnetic choke filter helps reduce radiation noise (can also be used on output).
EMC filter (Note 4)	Reduces the conducted noise on the power supply wiring generated by the inverter. Connect to the inverter input side.
Radio noise filter (Capacitor filter)	This capacitor filter reduces radiated noise from the main power wires in the inverter input side.
DC link choke	Suppresses harmonics generated by the inverter.
Output side noise filter	Reduces radiated noise from wiring in the inverter output side.
Radio noise filter	Electrical noise interference may occur on nearby equipment such as a radio receiver. This magnetic choke filter helps reduce radiated noise (can also be used on input).
AC reactor	This reactor reduces the vibration in the motor caused by the inverter's switching waveforms, by smoothing the waveforms to approximate commercial power quality. It is also useful when wiring from the inverter to the motor is more than 10m in length, to reduce harmonics.
LCR filter	Sine wave shaping filter for the output side.

Note 4: If there are any thyristor equipments belonging to the same net, and a possibility that the surge voltage is given to the net, change the connecting order of above Input side AC reactor and EMC filter. (Connecting order: Net -> Fuse(Circuit Breaker -> EMC filter -> Input side AC reactor -> Inverter)  
Otherwise, there is a danger of damaging inverter and/or fire.

## Operator, Cable

### Operator

Model	Potentiometer	Remote Control	Copy function
NES1-OP	○		
OPE-SR mini	○	○	
OPE-SBK		○	
OPE-SR	○	○	
WOP		○	○

### Cable

#### Cable <ICS-1, 3>

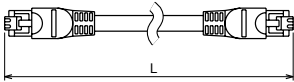

Model	Cable Length
ICS-1	1m(3.3ft)
ICS-3	3m(9.8ft)

### 4X-KITmini (For installation with OPE-SR mini)

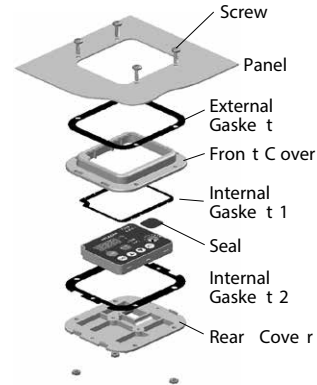

You can mount the keypad with the potentiometer for a NEMA1 rated installation. The kit also provides for removing the potentiometer knob to meet NEMA 4X requirements, as shown (part no.4X-KITmini).

## Operator

### <NES1-OP>



### <OPE-SR mini>



### <OPE-SBK (SR)>



### <WOP>



### Dimensions (Unit:mm (inch)) Inches for reference only)

#### <NES1-OP>

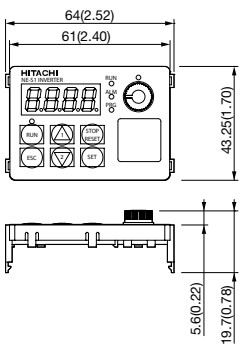

\*Built-in keypad for NES1, so this is not expandable with remote cable.

#### <OPE-SR mini>

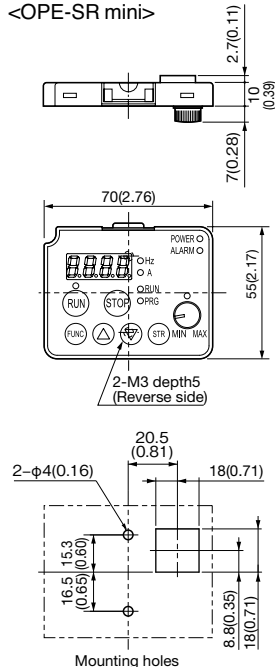

#### <OPE-SBK (SR)>

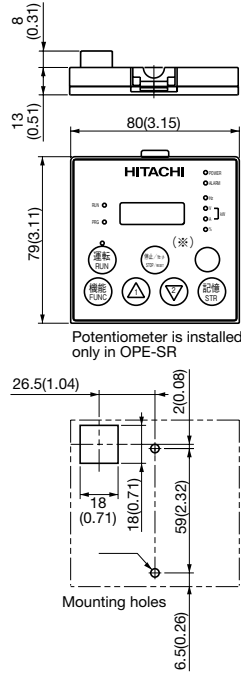

#### <WOP>

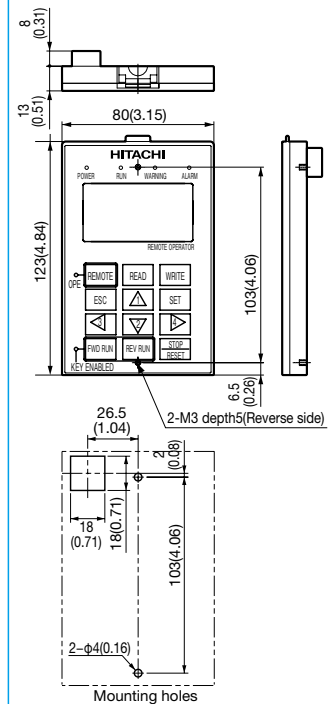

# Torque characteristics & De-rating curves

## Torque characteristics

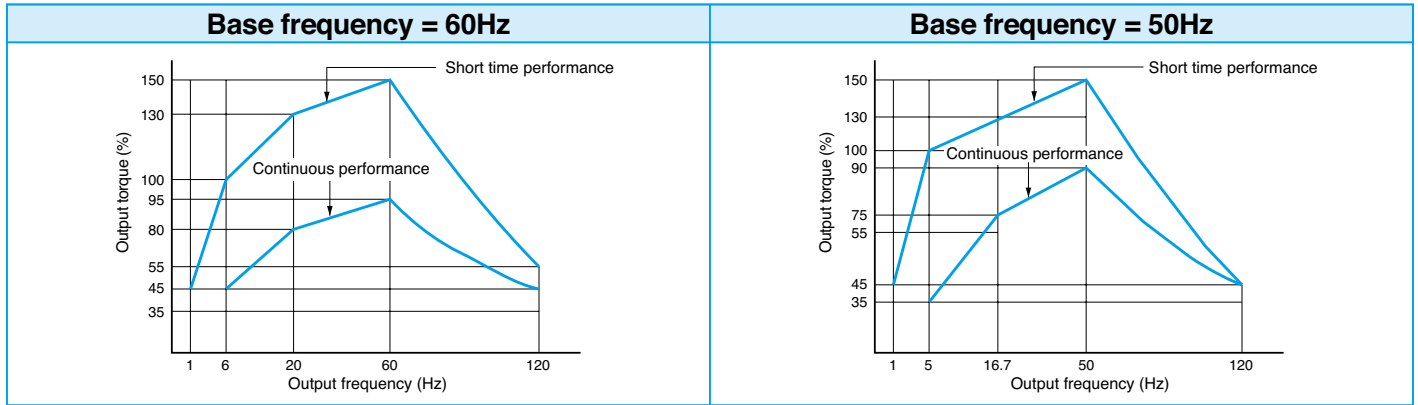

## De-rating Curves

The maximum available inverter current output is limited by the carrier frequency and ambient temperature as shown below. Choosing a higher carrier frequency tends to decrease audible noise, but it also increases the internal heating of the inverter, thus decreasing the maximum current output capability.

007SB,015LB,022LB,007H,015HB and 022HB is not require derating at ambient temperature 50°C,  
And Derating properties are improved by attaching FFM at the NES1-015SB,NES1-022SB and NES1-040HB.  
(Note: The figure below applied in the product since August 2012.)

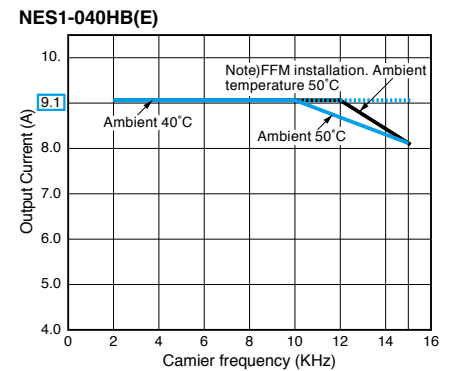
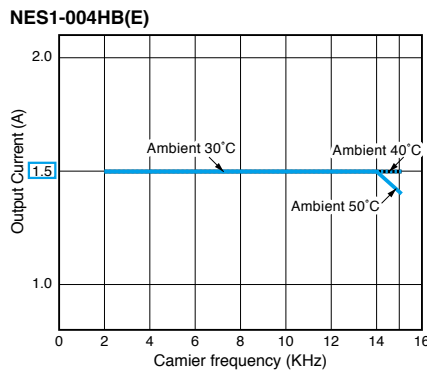
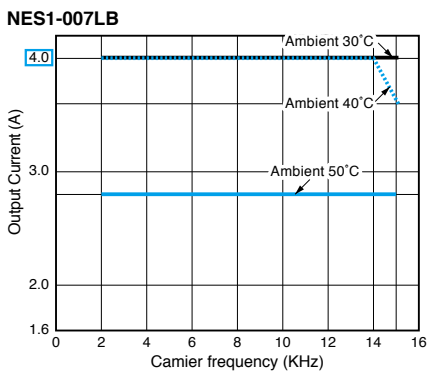
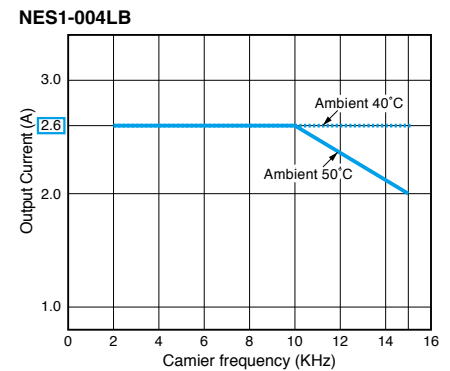
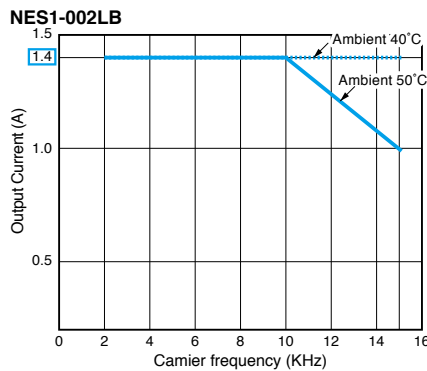
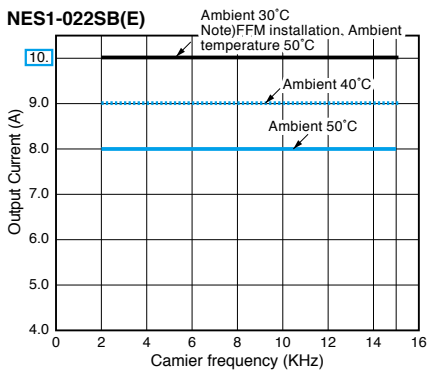
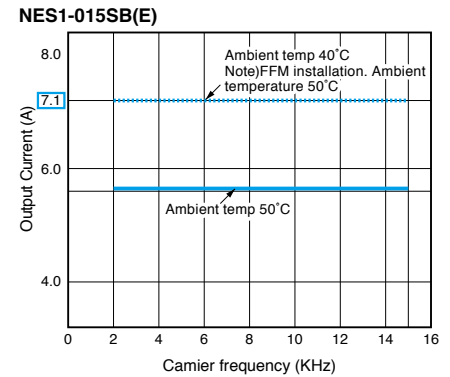
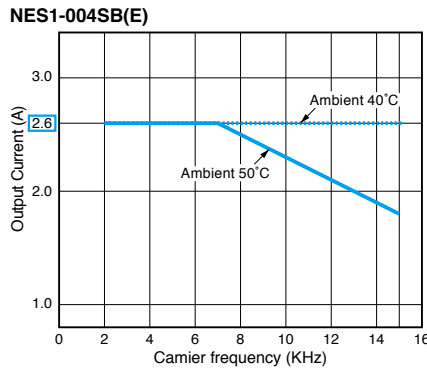
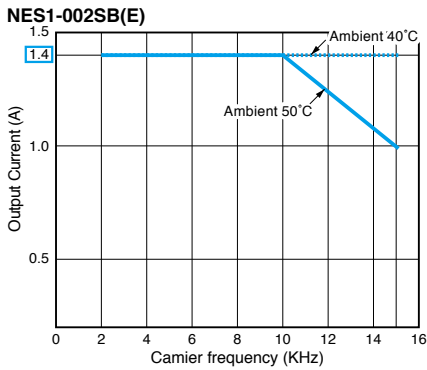
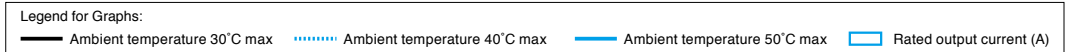



# For Correct Operation

## Application to Motors

### Application to general-purpose motors

Operating frequency	The overspeed endurance of a general-purpose motor is 120% of the rated speed for 2 minutes (JIS C4,004). For operation at higher than 60Hz, it is required to examine the allowable torque of the motor, useful life of bearings, noise, vibration, etc. In this case, be sure to consult the motor manufacturer as the maximum allowable rpm differs depending on the motor capacity, etc.
Torque characteristics	The torque characteristics of driving a general-purpose motor with an inverter differ from those of driving it using commercial power (starting torque decreases in particular). Carefully check the load torque characteristic of a connected machine and the driving torque characteristic of the motor.
Motor loss and temperature increase	The torque characteristics of driving a general-purpose motor with an inverter differ from those of driving it using commercial power
Noise	When run by an inverter, a general-purpose motor generates noise slightly greater than with commercial power.
Vibration	When run by an inverter at variable speeds, the motor may generate vibration, especially because of (a) unbalance of the rotor including a connected machine, or (b) resonance caused by the natural vibration frequency of a mechanical system. Particularly, be careful of (b) when operating at variable speeds a machine previously fitted with a constant speed motor. Vibration can be minimized by (1) avoiding resonance points using the frequency jump function of the inverter, (2) using a tireshaped coupling, or (3) placing a rubber shock absorber beneath the motor base.
Power transmission mechanism	Under continued, low-speed operation, oil lubrication can deteriorate in a power transmission mechanism with an oil-type gear box (gear motor) or reducer. Check with the motor manufacturer for the permissible range of continuous speed. To operate at more than 60Hz, confirm the machine's ability to withstand the centrifugal force generated.

### Application to special motors

Gear motor	The allowable rotation range of continuous drive varies depending on the lubrication method or motor manufacturer. (Particularly in case of oil lubrication, pay attention to the low frequency range.)
Brake-equipped motor	For use of a brake-equipped motor, be sure to connect the braking power supply from the primary side of the inverter.
Pole-change motor	There are different kinds of pole-change motors (constant output characteristic type, constant torque characteristic type, etc.), with different rated current values. In motor selection, check the maximum allowable current for each motor of a different pole count. At the time of pole changing, be sure to stop the motor. Also see: Application to the 400V-class motor.
Submersible motor	The rated current of a submersible motor is significantly larger than that of the general-purpose motor. In inverter selection, be sure to check the rated current of the motor.
Explosion-proof motor	Inverter drive is not suitable for a safety-enhanced explosion-proof type motor. The inverter should be used in combination with a pressure-proof explosion-proof type of motor. *Explosion-proof verification is not available for NE-S1 Series.
Synchronous (MS) motor High-speed (HFM) motor	In most cases, the synchronous (MS) motor and the high-speed (HFM) motor are designed and manufactured to meet the specifications suitable for a connected machine. As to proper inverter selection, consult the manufacturer.
Single-phase motor	A single-phase motor is not suitable for variable-speed operation by an inverter drive. Therefore, use a three-phase motor.

### Application to the 400V-class motor

A system applying a voltage-type PWM inverter with IGBT may have surge voltage at the motor terminals resulting from the cable constants including the cable length and the cable laying method. Depending on the surge current magnification, the motor coil insulation may be degraded. In particular, when a 400V-class motor is used, a longer cable is used, and critical loss can occur, take the following countermeasures:

- (1) install the LCR filter between the inverter and the motor,
- (2) install the AC reactor between the inverter and the motor, or
- (3) enhance the insulation of the motor coil.

## Notes on Use

### Drive

Run/Stop	Run or stop of the inverter must be done with the keys on the operator panel or through the control circuit terminal. Do not operate by installing a electromagnetic contactor (MC) in the main circuit.
Emergency motor stop	When the protective function is operating or the power supply stops, the motor enters the free run stop state. When an emergency stop is required or when the motor should be kept stopped, use of a mechanical brake should be considered.
High-frequency run	A max. 400Hz can be selected on the NE-S1 Series. However, a two-pole motor can attain up to approx. 24,000 rpm, which is extremely dangerous. Therefore, carefully make selection and settings by checking the mechanical strength of the motor and connected machines. Consult the motor manufacturer when it is necessary to drive a standard (general-purpose) motor above 60Hz. A full line of high-speed motors is available from Hitachi.

### About the load of a frequent repetition use

About frequent repetition use (crane, elevator, press, washing machine), a power semiconductor (IGBT, a rectification diode, thyristor) in the inverter may come to remarkably have a short life by thermal fatigue.

The life can be prolonged by lower a load electric current. Lengthen acceleration / deceleration time. Lower carrier frequency. or increasing capacity of the inverter.

### About the use in highlands beyond 1,000m above sea level

Due to the air density decreasing, whenever standard inverters are used for altitudes above 1,000m, the following conditions are additionally required for proper operation. In application for operation over 2,500m, kindly contact your nearest sales office for assistance.

#### 1. Reduction of inverter rated current

Current rating has to be reduced 1% for every 100m that exceeds from an altitude of 1,000m.

For example, for inverters placed at an altitude of 2,000m, the rated current has to be reduced 10%(Rated current x0.9) from its original amount.  $\{(2,000m-1,000m)/100m \times 1\% = 10\%$

#### 2. Reduction of breakdown voltage

Whenever an inverter is used at altitudes beyond 1,000m, the breakdown voltage decreases as follows:

1,000m or less: 1.00 / 1,500m: 0.95 / 2,000m: 0.90 / 2,500m: 0.85

As mentioned in the instruction manual, please avoid any pressure test.

## Installation location and operating environment

Avoid installation in areas of high temperature, excessive humidity, or where moisture can easily collect, as well as areas that are dusty, subject to corrosive gasses, mist of liquid for grinding, or salt. Install the inverter away from direct sunlight in a well-ventilated room that is free of vibration. The inverter can be operated in the ambient temperature range from -10 to 50°C. (Carrier frequency and output current must be reduced in the range of 40 to 50°C.)

## Main power supply

<p>Installation of an AC reactor on the input side</p>	<p>In the following examples involving a general-purpose inverter, a large peak current flows on the main power supply side, and is able to destroy the converter module. Where such situations are foreseen or the connected equipment must be highly reliable, install an AC reactor between the power supply and the inverter. Also, where influence of indirect lightning strike is possible, install a lightning conductor.</p> <p>(A) The unbalance factor of the power supply is 3% or higher. (Note)                  (B) The power supply capacity is at least 10 times greater than the inverter capacity (the power supply capacity is 500 kVA or more).                  (C) Abrupt power supply changes are expected.</p> <p>Examples:                  (1) Several inverters are interconnected with a short bus.                  (2) A thyristor converter and an inverter are interconnected with a short bus.                  (3) An installed phase advance capacitor opens and closes.</p> <p>In cases (A), (B) and (C), it is recommended to install an AC reactor on the main power supply side.                  Note: Example calculation with <math>V_{RS} = 205V</math>, <math>V_{ST} = 201V</math>, <math>V_{TR} = 200V</math>  <math>V_{RS}</math> : R-S line voltage, <math>V_{ST}</math> : S-T line voltage, <math>V_{TR}</math> : T-R line voltage</p> $\text{Unbalance factor of voltage} = \frac{\text{Max. line voltage (min.)} - \text{Mean line voltage}}{\text{Mean line voltage}} \times 100$ $= \frac{V_{RS} - (V_{RS} + V_{ST} + V_{TR})/3}{(V_{RS} + V_{ST} + V_{TR})/3} \times 100 = \frac{205 - 202}{202} \times 100 = 1.5(\%)$
<p>Using a private power generator</p>	<p>An inverter run by a private power generator may overheat the generator or suffer from a deformed output voltage waveform of the generator. Generally, the generator capacity should be five times that of the inverter (kVA) in a PWM control system, or six times greater in a PAM control system.</p>

## Notes on Peripheral Equipment Selection

<p>Wiring connections</p>	<p>(1) Be sure to connect main power wires with R(L1), S(L2), and T(L3) terminals (input) and motor wires to U(T1), V(T2), and W(T3) terminals (output). (Incorrect connection will cause an immediate failure.)                  (2) Be sure to provide a grounding connection with the ground terminal (⊕).</p>
<p>Wiring between inverter and motor</p>	<p>Electromagnetic contactor                  When an electromagnetic contactor is installed between the inverter and the motor, do not perform on-off switching during running operation.</p> <p>Thermal relay                  When used with standard applicable output motors (standard three-phase squirrel-cage four-pole motors), the NE-S1 Series does not need a thermal relay for motor protection due to the internal electronic protective circuit. A thermal relay, however, should be used:                  • during continuous running outside a range of 30 to 60 Hz.                  • for motors exceeding the range of electronic thermal adjustment (rated current).                  • when several motors are driven by the same inverter; install a thermal relay for each motor.                  • The RC value of the thermal relay should be more than 1.1 times the rated current of the motor. Where the wiring length is 10 m or more, the thermal relay tends to turn off readily. In this case, provide an AC reactor on the output side or use a current sensor.</p>
<p>Installing a circuit breaker</p>	<p>Install a circuit breaker on the main power input side to protect inverter wiring and ensure personal safety. Choose an inverter-compatible circuit breaker. The conventional type may malfunction due to harmonics from the inverter. For more information, consult the circuit breaker manufacturer.</p>
<p>Wiring distance</p>	<p>The wiring distance between the inverter and the remote operator panel should be 20 meters or less. Shielded cable should be used on the wiring. Beware of voltage drops on main circuit wires. (A large voltage drop reduces torque.)</p>
<p>Earth leakage relay</p>	<p>If the earth leakage relay (or earth leakage breaker) is used, it should have a sensitivity level of 15 mA or more (per inverter).</p>
<p>Phase advance capacitor</p>	<p>Do not use a capacitor for power factor improvement between the inverter and the motor because the high-frequency components of the inverter output may overheat or damage the capacitor.</p>

## High-frequency Noise and Leakage Current

- (1) High-frequency components are included in the input/output of the inverter main circuit, and they may cause interference in a transmitter, radio, or sensor if used near the inverter. The interference can be minimized by attaching noise filters (option) in the inverter circuitry.
- (2) The switching action of an inverter causes an increase in leakage current. Be sure to ground the inverter and the motor.

## Lifetime of Primary Parts

Because a DC bus capacitor deteriorates as it undergoes internal chemical reaction, it should normally be replaced every five years. Be aware, however, that its life expectancy is considerably shorter when the inverter is subjected to such adverse factors as high temperatures or heavy loads exceeding the rated current of the inverter. The approximate lifetime of the capacitor is as shown in the figure at the right when it is used 12 hours daily (according to the "Instructions for Periodic Inspection of General-Purpose Inverter" (JEMA).) Also, such moving parts as a cooling fan should be replaced. Maintenance inspection and parts replacement must be performed by only specified trained personnel. Please plan to replace new INV depends on the load, ambient condition in advance.

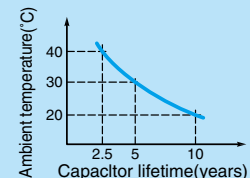

## Precaution for Correct Usage

- Before use, be sure to read through the Instruction Manual and QRG (<http://www.hitachi-ies.co.jp/english/products/inv/nes1/index.htm>) to insure proper use of the inverter.
- Note that the inverter requires electrical wiring; a trained specialist should carry out the wiring.
- The inverter in this catalog is designed for general industrial applications. For special applications in fields such as aircraft, outer space, nuclear power, electrical power, transport vehicles, clinics, and underwater equipment, please consult with us in advance.
- For application in a facility where human life is involved or serious losses may occur, make sure to provide safety devices to avoid a serious accident.
- The inverter is intended for use with a three-phase AC motor. For use with a load other than this, please consult with us.

Information in this brochure is subject to change without notice.

